



CATÁLOGO 2026



MADERAS CASAS, S.A.

C/MARQUÉS DE LEMA 160
44550 ALCORISA (TERUEL)

MADERAS TERUEL, S.L.

POL. LA PAZ C/ LISBOA 4
44195 TERUEL (TERUEL)

MADERAS CALATAYUD, S.L.

MADERAS RACASO, SL.

POL MALPICAC/F OESTE 15-16
CP50016 ZARAGOZA

2026.5

01.01.2026

www.maderascasasteruel.com



01.	MADERA (Cepillado, Abeto Aserrado, Pino Insignis, Perfil KKK)	03-09
02.	MADERA TRATADA (Rollizos, Tratada y Herrajes)	10-12
03.	VIGA LAMINADA Y TARIMA (Viga laminada, Cubiertas, Perfil Laminada, CLT, Tarima, forro de viga)	13-18
04.	FRISOS DE MADERA (Frisonoble, Frisolar)	19-21
05.	SANDWICH (Thermochip)	22
06.	AISLANTES (Lana de Roca, Corcho, Onduline)	22-25
07.	PINTURAS (Tinte, Aceite de Teka, Matacarcomas)	26-29
08.	AGLOMERADO	30
09.	AGLOMERADO HIDROFUGO	31
10.	OSB	32
11.	FIBRA DM	33-34
12.	MELAMINAS (Superpan, Kronos, Gama Duo)	35-47
13.	TIRAS CANTEADAS Y TABLEX	48-49
14.	RECHAPADO Y CONTRACHAPADO (Natural, Antiderrapante, Calabo)	50-55
15.	TABLEROS ALISTONADOS (Lama Entera, Finger)	56-58
16.	TABLERO COMPACTO	59-60
17.	MARCOS (Premarcos)	61-64
18.	PUERTAS (Paso, maciza, PVC, Melamina)	65-93
19.	ARMARIOS (Armarios, Perfiles, Cajones)	94-105
20.	TAPETAS Y BATIDEROS	106-107
21.	VENTANAS	108-113
22.	COCINAS (Puertas, Complementos, Módulos)	114-142
23.	SUELOS LAMINADOS/MACIZO/VINILO	143-193
24.	MOPA Y RODAPIE	194-198
25.	FRISOS SINTETICOS (Frisos y celosías)	199-201
26.	FERRETERIA / PASAMANOS (Tornillos, Herrajes)	202-205
27.	JARDINERÍA (césped)	206-207

1. MADERA

CEPILLADO

ABETO CEPILLADO VI 220*45 mm

ABETO CEPILLADO SF 150*47mm

ABETO CEPILLADO 235*19mm

PINO FLANDES VI 200*25mm

PINO FLANDES VI 220*25mm



ABETO SERRADO

22*125 mm	38*275mm
25*150mm	47*225mm
38*150mm	47*245mm
38*200mm	47*250mm
38*225mm	50*150mm
38*250mm	50*225mm
	75*225mm



PINO INSIGNIS

32*200 mm	50*300mm
32*250mm	50*400mm
38*225mm	50*450mm
38*250mm	63*300mm
38*300mm	75*300mm
50*150mm	



**STOCK****STENVALLS****PINO FLANDES/ROJO**

Escuadrias	COMO - CAE	V	VI	VI-2	SF
100 x 200mm			+		+
100 x 150mm					+
75 x 225mm	+	+			
75 x 200mm	+	+			
75 x 175mm	+	+			
75 x 150mm	+	+			
75 x 125mm	+	+			
75 x 100mm			+		
63 x 200mm	+	+			
63 x 175mm	+	+			
63 x 150mm	+	+			
63 x 125mm	+	+			
63 x 100mm	+	+			
50 x 225mm	+	+	+		
50 x 200mm	+	+	+		
50 x 175mm		+	+		
50 x 150mm	+	+			
50 x 125mm	+				
50 x 100mm	+				
44 x 200mm					
44 x 175mm					
44 x 125mm					
38 x 225mm	+	+	+		
38 x 200mm	+	+	+		
38 x 175mm	+				
38 x 150mm	+	+			
38 x 125mm					
38 x 100mm					+
32 x 225mm	+		+		
32 x 200mm	+	+	+	+	
32 x 175mm					
32 x 150mm	+				
32 x 125mm					
25 x 200mm	+	+	+		
25 x 175mm	+	+			
25 x 150mm	+	+	+		
25 x 125mm	+				
25 x 100mm	+	+	+		

PINO FLANDES A+B

Escuadrías	A+B	B	V
75 x 225mm	+		
75 x 200mm	+		
75 x 175mm			
75 x 150mm			
75 x 125mm	+	+	
75 x 100mm	+	+	
75 x 90mm	+		
63 x 225mm			
63 x 200mm	+		
63 x 175mm			
63 x 150mm			
63 x 125mm	+	+	
63 x 100mm	+	+	
63 x 90mm	+		
50 x 225mm	+		
50 x 200mm	+		
50 x 175mm			
50 x 150mm		+	
50 x 125mm			
50 x 100mm			
38 x 225mm	+		+
38 x 200mm	+		+
38 x 150mm			
32 x 225mm			
32 x 200mm			
32 x 175mm			
32 x 150mm			
32 x 125mm			
25 x 200mm			
25 x 175mm			
25 x 150mm			
25 x 125mm			
25 x 100mm			



MADERA

VIGA PINO PAIS

SECCIÓN	LARGOS
150*100	4 metros – 5 metros – 6 metros
200*100	4 metros – 5 metros – 6 metros
200*150	4 metros – 5 metros – 6 metros
200*200	4 metros – 6 metros

VIGA PINO REDONDA PELADA UNA CARA

DIÁMETRO	LARGOS
14CM	4 metros – 5 metros – 6 metros
16CM (@)	4 metros – 5 metros – 6 metros
18CM	4 metros – 5 metros – 6 metros



VIGA PINO PAIS



VIGA PINO REDONDA PELADA

LISTONES DE MADERA

LISTONES ABETO

20*13mm	45*45mm
25*25mm	60*35mm
35*30mm (#)	60*40mm (#)
30*20mm (#)	60*45mm
40*20mm (#)	70*35mm
40*40mm (#)	70*45mm
45*10mm	70*47mm
45*15mm	70*70mm (#)
45*20mm	80*40mm (#)
45*30mm	90*28mm
	140*20mm



RASTREL TROPICAL FINGER

2000*50*30mm



OTRAS MADERAS

ROBLE



GRUESO

- 27mm
- 32mm
- 52mm
- 65mm
- 76mm

PINO MELIS



GRUESO

- 27mm
- 32mm
- 52mm
- 65mm
- 76mm

PINO GALLEGO



GRUESO

- 20mm
- 25mm
- 30mm

HAYA VAP.



GRUESO

- 27mm
- 32mm
- 60mm
- 65mm

IROKO



GRUESO

- 27mm
- 50 mm
- 63mm
- 76mm
- 100 mm

PERFIL LAMINADO FINGER (KKK)

MEDIDAS

PERFIL 96*75*6000

PERFIL 96*96*6000

PERFIL 72*86*6000

PERFIL 72*75*6000

PERFIL 72*95*6000

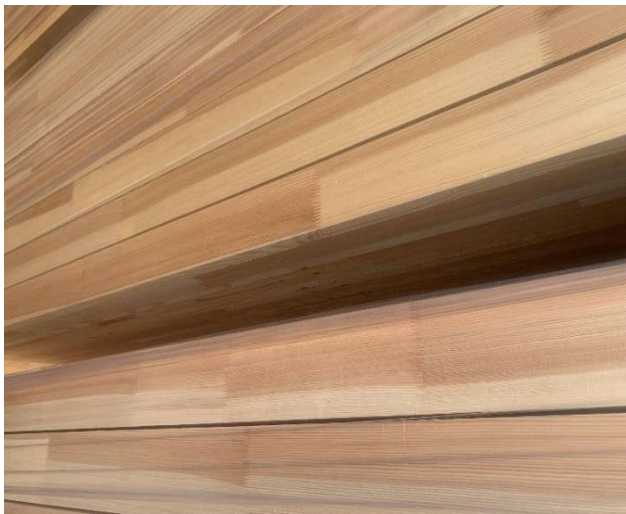

2. MADERA TRATADA

ROLLIZO CILINDRADO

Los **rollizos** cilíndricos y calibrados de madera están **tratados** por el proceso de **autoclave** para una **clase de riesgo 4** (madera en contacto directo con el suelo o con agua dulce y expuesta a una humidificación permanente sin mantener contacto con agua salada).



DIÁMETRO	LARGOS
Diam. 6 (con punta)	2m
Diam. 8	2m – 2.5m – 3m
Diam. 8 (con punta)	2 – 2.5m
Diam. 10	1.5m – 2m – 2.5m – 3m
Diam. 12	2m – 3m



HERRAJES

Unión Tejana: para unión de postes verticales y horizontales en un vallado Tejano o torneado



MATERIAL

UNIÓN TEJANA

TORNILLO

SOPORTE REDONDO

STOCK

MADERA PINO TRATADA

Apta para uso exterior o interior



SECCIÓN

92*22mm	-	142*43mm
92*43mm	-	142*68mm
92*92mm	-	142*92mm
142*22mm	-	190*90mm
142*27mm		



RASTREL TRATADO

28*45mm
38*45mm (# afe)
45*80mm



Consultar Disponibilidad.

1. MESA PICNIC MADERA TRATADA



2. PAPELERA MADERA TRATADA



3. CUBRECONTENEDORES



4. PANEL INFORMATIVO



5. VALLA DE MADERA



¡NUEVO!

VALLA DE MADERA AHORA
EN **STOCK**.

MEDIDA: 2050*1000mm

3. VIGA LAMINADA Y TARIMA

Las **vigas laminadas** son elementos para construcciones en madera que se fabrican a partir de tablonces de abeto secados técnicamente, a los que se les recorta los defectos que disminuyen la estabilidad y los defectos ópticos tales como nudos, grandes bolsas de resina. Eliminando los puntos débiles y superponiendo capas se obtiene el producto de alta tecnología.

Disponibilidad almacén:

SECCIONES Alto x Ancho	MEDIDAS CORTE VIGUETAS	SECCIONES Alto x Ancho	MEDIDAS CORTE VIGAS DE CARGA
100*100	3 - 4 - 6 - 8 - 12	240*200	3.37 - 4 - 6 - 6.75 - 8
140*140 (facturamos 160*140)		240*240	
120*80		280*200	
160*80	320*200		
160*100	320*240		
160*120	360*200		
160*140	360*240		
200*80	400*200		
200*100	440*240		
200*120			
200*140	3.37 - 4 - 6 - 6.75 - 8	3.37 - 4 - 6 - 6.75 - 8 - 12 - 13.5	
200*160			
200*200			
240*100	12 - 13.5	10 - 13.5	
240*120			
240*140			
280*120			
280*140			
320*120			
320*160			

- SECCIÓN DE VIGAS EN ANCHO DE 20mm
- SECCIÓN DE VIGAS EN ALTO DE 40mm
- SECCIÓN Y LARGO A MEDIDA, BAJO PEDIDO. CONSULTAR PRECIO Y PLAZO DE ENTREGA
- POSIBILIDAD DE SERVIR CUBIERTAS MECANIZADAS, BARNIZADAS, ETC.
- POR EL VOLUMEN QUE CONLLEVA DISPONER DE TODAS LAS SECCIONES. CONSULTEN ANTES NUESTRO STOCK.

CUBIERTAS DE MADERA



TIJERA ESPAÑOLA

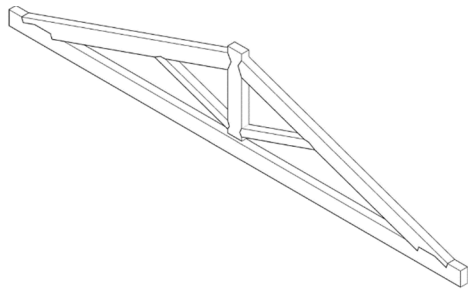

COLAS DE MILANO EN LIMATESA

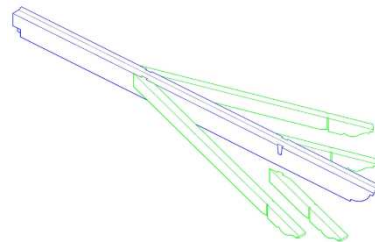

MECANIZADO DE VIGAS

CANETES

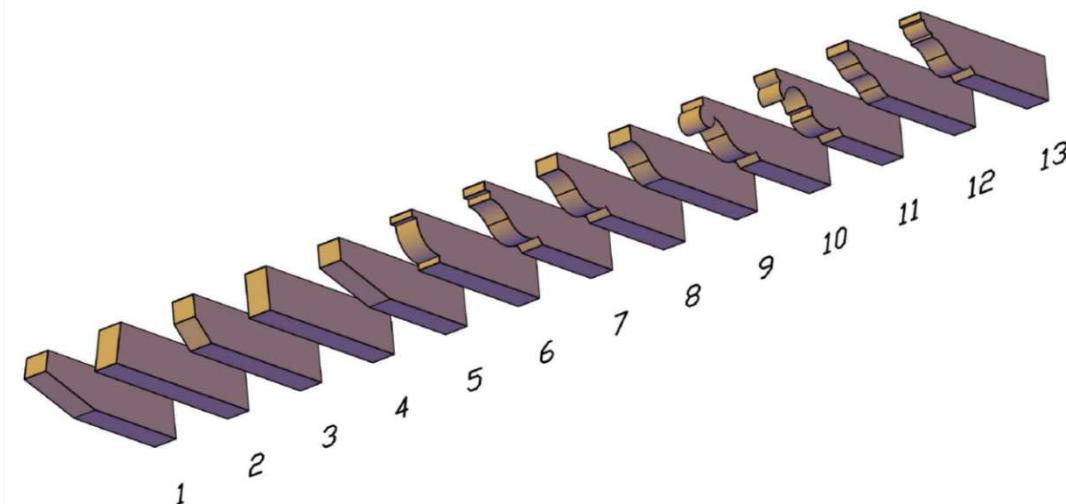

Stock

FORRO DE VIGAS

TRADICIONAL 143*45 mm.ml



CANTO RECTO 143*45 mm.ml



MADERA CONTRALAMINADA CLT

Madera laminada Cruzada. Así podemos decir que el CLT es un laminado de tablas que se cruzan usando como referencia las vetas naturales.

PERFIL LAMINADO

Perfiles de elementos H B E según DIN 1052

Se usan como elementos para techos, cubiertas o cerramientos:

1. En construcciones de madera maciza
2. Construcciones de bastidores de madera
3. En la construcción de estructuras
4. En construcciones de piedra maciza

MEDIDAS

Perfil Machihembrado 360*100*13500

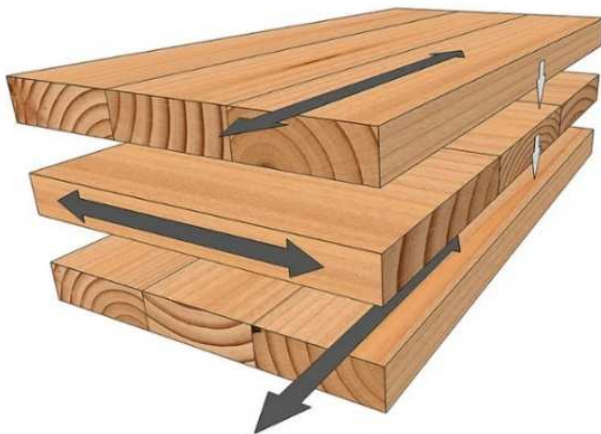

Consultar Disponibilidad.

CUÑAS DE MADERA



MEDIDAS

CUÑAS 56*50*0.5mm.250ud paquete

Posibilidad de traer otras

ESTAQUILLAS DE MADERA



MEDIDAS

ESTAQUILLA 400*30*30mm.25ud paquete

ESTAQUILLA 500*32*32mm.25ud paquete

Posibilidad de traer otras medidas

STOCK

TARIMA

TARIMA ABETO

- 1- ABETO V 146*19 mm
- 2- ABETO BC 145*23 mm
- 3- ABETO 190*28 mm
- 4- ABETO 170*22mm

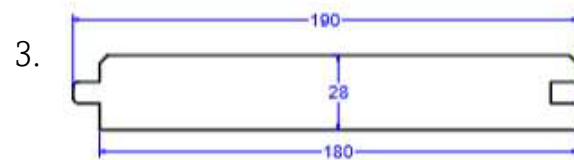
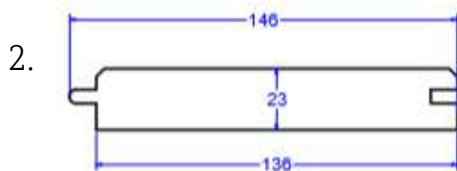
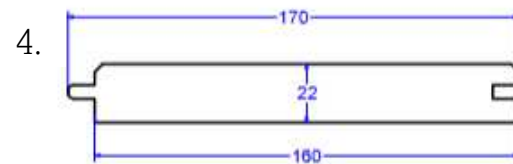
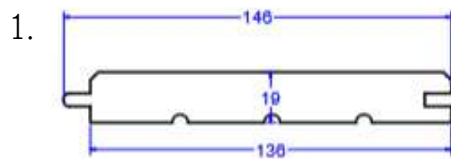

TARIMA PINO

- 1- PINO FLANDES C/C 145*22mm
- 2- PINO FLANDES V 195*28mm (@)
- 3- PINO FLANDES V 120*22mm
- 4- PINO GALLEGO 175*23mm (afe)



4. FRISOS DE MADERA



FRISONOBLE (95*10)



FRISONOBLE (120*13)



FRISONOBLE

FRISO ABETO NATURAL 95*10mm m2

FRISO ABETO BARNIZADO 95*10mm m2

FRISO ABETO TEÑIDO MIEL 95*10mm m2

FRISO ABETO TEÑIDO NOGAL 95*10mm m2

FRISO ABETO BLANCO NEVISCA 120*13mm m2

FRISO ABETO MARRON SENDA 120*13mm m2

STOCK



El **FRISOLAR** admite algunos defectos naturales de la madera en las piezas como resina seca, nudos y pequeñas grietas

FRISOLAR

FRISO ABETO NATURAL 95*10mm m2

FRISO ABETO BARNIZADO 95*10mm m2

FRISO ABETO TEÑIDO MIEL 95*10mm m2



FRISO DE MADERA MATES

FRISONOBLE ALISTONADO MATE (96*13)



BARNIZ BLANCO NÓRDICO



BARNIZ ABETO NATURAL



TEÑIDO MIEL



STOCK

FRISONOBLE MATE



COMPLEMENTOS FRISOS

COMPLEMENTOS FRISONOBLE Y FRISOLAR

- RODAPIE 70*10 S/B
- RODAPIE 70*10 BARNIZ
- RODAPIE 70*10 TEÑIDOS
- RINCONERA S/B
- RINCONERA BARNIZ
- RINCONERA TEÑIDOS
- CANTONERA S/B
- CANTONERA BARNIZ
- CANTONERA TEÑIDOS

[34x34]



[23x23]



[70x10]



REVESTIMIENTOS DE PARED

MEDIDAS

WALL HDF-1 LB-2200-M REDONDO NOGAL	2800*101*18mm (6 x paq. = 1,697m ²)
WALL HDF-1 LB-3771 ACANALADO TEKA	2800*121*18mm (4x paq. = 1,355m ²)
WALL HDF-1 LB-2050 ONDA SAHARA CREAM	2800*140*18mm (4 x paq. = 1,568m ²)
WALL HDF-1 LB-3783 ACANALADO ESTRECHO BLANCO SOFT TOUCH	2800*158*12mm (4 x paq. = 1,770m ²)



REDONDO NOGAL ACANALADO TEKA



ONDA SAHARA CREAM ACANALADO ESTRECHO BLANCO SOFT

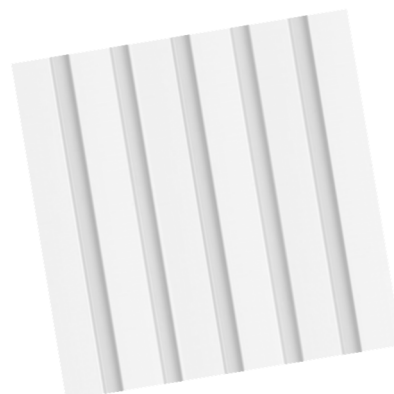

5. PANEL SANDWICH

THERMOCHIP BASIC



MATERIAL EN STOCK:

THERMOCHIP BASIC AAH/Friso **Abeto Barniz 10mm**- Poliestireno 80 mm-
Aglom. hidróf. 16mm/ 2400*55*96 mm

THERMOCHIP BASIC AAH/Friso **Abeto Sin Barniz 10mm**- Poliestireno 80 mm-
Aglom. hidróf. 16mm/ 2400*55*96 mm

****SE PUEDE SUMINISTRAR CUALQUIER GAMA, SIEMPRE BAJO PEDIDO A FÁBRICA****



6. AISLANTES TERMICOS

AISLANTES

IMPERMEABILIZACIÓN DE TEJADOS: ONDULINE BAJO TEJA

Placas impermeables Onduline Bajo Teja DRS forman una solución definitiva contra goteras y humedades



- Fáciles de instalar
- Ligeras
- Solución perfecta para reparación de tejados: no sobrecarga la estructura

Su formato ondulado aporta la **ventilación** de tejado para evitar condensaciones por humedades



SISTEMA DE CUBIERTA Y FACHADA: ONDUVILLA

Teja **asfáltica de Onduline** para la impermeabilización y el acabado estético de cubiertas inclinadas.

Ideal para:

- Casetas
- Porches
- Pérgolas
- Cenadores



Impermeable



Ventilación
Cubierta



Ligereza



Fácil
Instalación



Baja
Pendiente



Resistente
a impactos



Estética

GAMA BARDOLINE

Teja asfáltica que garantiza tejado protegido frente goteras y humedades.

- Instalación en tejados de cualquier forma con pendiente mayor al 20%
- Formatos disponibles: rectangular y ovalado
- Colores disponibles: rojo, verde, marrón y negro.
- Alta resistencia frente a lluvia, heladas y viento



AISLANTE UNIBULLE

Aislante universal para forjados, buhardillas paredes, bajo parquet y rotura de puerta

Resistencia térmica con 2 cámaras de aire en pared: $R = 1,45 \text{ m}^2 \cdot \text{K}/\text{W}$

MATERIAL DISPONIBLE

ROLLOS DE 60m²



APLICACIONES



STOCK



POLIESTIRENO EXTRUIDO

El poliestireno extruido **XPS CW** es el panel de gran formato para el aislamiento de muros en cámara de aire. Presenta una superficie lisa y un acabado machiembrado para facilitar su colocación en vertical.

MEDIDAS

2600*600*40mm

2600*600*60mm

2600*600*80mm

2600*600*100mm





7. PINTURA

Gran variedad en pinturas al agua



CONSULTAR NUESTRA AMPLIA GAMA DE COLORES

STOCK



IRURENA GROUP

PINTURA Y TRATAMIENTOS

PROTECTOR DECORATIVO

Acabado coloreado que realza la veta de la madera. Protección contra el sol, lluvia y el viento. Cumple la Norma EN927 de “Durabilidad en condiciones de intemperie”

- Excelente adherencia a todo tipo de maderas (incluidas las de origen tropical y las coníferas)
- Fácil mantenimiento. Basta con lijar suavemente y aplicar una nueva mano del protector decorativo
- Se recomienda el **PROTECTOR DECORATIVO** para uso en ambientes de interior

MATERIAL	L
IRUXIL W PROTECTOR BLANCO	0.75
IRUXIL W PROTECTOR BLANCO	4
IRUXIL W PROTECTOR NOGAL	0.75
IRUXIL W PROTECTOR NOGAL	4
IRUXIL W PROTECTOR ROBLE	0.75
IRUXIL W PROTECTOR ROBLE	4
IRUXIL W PROTECTOR TEKA	0.75
IRUXIL W PROTECTOR TEKA	4
IRUXIL W PROTECTOR CASTAÑO 440	0.75
IRUXIL W PROTECTOR INCOLORO	0.75
IRUXIL W PROTECTOR INCOLORO	4

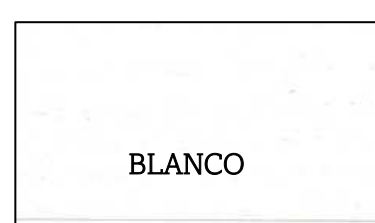

STOCK



IRURENA GROUP

BARNIZ INTERIORES: ACABADO INCOLORO SATINADO

MATERIAL	Litros
IRURENA BARNIZ INTERIORES	0.75
IRURENA BARNIZ INTERIORES	4



PROTECTOR DECORATIVO: TARIMA EXTERIOR

MATERIAL	Litros
IRURENA PROTECTOR TARIMA EXTERIOR	0.75
IRURENA PROTECTOR TARIMA EXTERIOR	4



ACEITE DE TEKA

MATERIAL	Litros
IRURENA ACEITE DE TEKA	1
IRURENA PROTECTOR TARIMA EXTERIOR	4



MATACARCOMAS

MATERIAL	Litros
IRURENA MATACARCOMAS	1
IRURENA MATACARCOMAS	4



RENOVADOR

MATERIAL	Litros
IRURENA RENOVADOR	0.75



STOCK

8. TABLERO AGLOMERADO

TABLERO AGLOMERADO



Tablero de partículas de madera aglomerado: superficie lisa y compacta de fibra de madera.

MATERIAL	LARGO (mm)	ANCHO (mm)	10	16	19	25	30
AGLOMERADO	2440	1220	+	+	+	+	+
	2440	2100			+		
	2850	2100	+	+	+		
	3660	2100	+				

Consultar Disponibilidad.

9. AGLOMERADO HIDROFUGO

TABLERO AGLOMERADO HIDRÓFUGO

El **AGLOMERADO HIDRÓFUGO** pensado para ambientes húmedos.

Clasificación P3: aplicaciones de interior en ambiente húmedo.

MATERIAL

2440*1220*16 mm

2440*1220*19 mm



TABLERO AGLOMERADO HIDRÓFUGO MACHIHEMBADO

MATERIAL

2040*910*19 mm



MELAMINA MACHIHEMBADO

- Tablero estructural, clase técnica P4 para ambiente seco.
- Tablero con una cara lisa de color blanco y otra gris antideslizante
- Recomendado para altillos

MATERIAL

TABLERO SUPERPANTECH P4 Antideslizante Machiemb. 4C GRIS 2400*900*30 mm.m2

TABLERO SUPERPAN H TECH P5 SA TG4
2040*800*16 mm.m2



STOCK

10. TABLERO OSB 3

MATERIAL

2500*1250*9 mm
2500*1250*12mm
2500*1250*15mm
2500*1250*18mm
2500*1250*21mm



MATERIAL MACHIEMRADO 4C

2500*675*15mm
2500*675*18mm
2500*625*22mm



VENTAJAS

- Gran resistencia a la ruptura y torsión
- Ausencia de nudos
- Reciclaje sencillo
- Resistente a insectos



11. FIBRA DM

STOCK

CARACTERISTICAS

- Superficie homogénea y lisa
- No presenta vetas o nudos
- Gran variedad de tamaños y espesores
- Resistencia a la flexión y tracción
- Muy versátil de trabajar. Se puede fresar, mecanizar y curvar (dentro de parámetros lógicos)

El **tablero MDF ó FIBRA DM**: es un tablero de madera reconstituida fabricado con fibras de madera y resinas sintéticas, prensadas y sometidas a altas temperaturas para obtener un material de densidad media.

LARGO (mm)	ANCHO (mm)	2	3	4	5	6	7	9	10	12	14	15	16	17	19	22	25	28	30
2150	1220																		+
2250	1220							+		+	+	+			+	+			+
2440	1220	+			+	+		+		+			+	+	+	+			+
2440	2100		+	+			+						+		+				
2560	1220							+		+									
2750	1220				+	+		+		+		+			+	+			
2750	2100																		
2850	2100								+				+		+		+		+
3660	2070														+				
3050	1220							+		+		+			+				+
3660	2100								+										



TABLERO FIBRA DM HIDRÓFUGO

Se modifica la composición del tablero con el fin de mejorar su comportamiento frente a la humedad.

MATERIAL	MEDIDAS		GROSOR						
	LARGO (mm)	ANCHO (mm)	09	12	14	15	19	22	28
FIBRA DM HIDRÓFUGO	2250	1220	+	+	+	+	+	+	+
	2440	1220	+	+			+		+
	2750	1220	+	+		+	+	+	+
	2750	2100							
	3050	1220	+			+	+		

TABLERO FIBRA DM RANURADO

Tablero de fibras de madera con ranuras longitudinales decorativas

MATERIAL

2440*1220*9mm Horizontal

2440*1220*9mm Vertical



TABLERO FIBRA DM FINLIGHT

MATERIAL

2850*2100*35mm

VENTAJAS

- Ligero
- Resistente y estable
- Fácil de manipular, cortar y cantear



12. MELAMINA

Tablero compuesto por caras externas de fibra de madera e interior de partículas de madera, recubierto con papel decorativo impregnado con resinas melamínicas.

El Superpan Decor posibilita un mejor corte sin astillas

superPan[®]
patente n° 99966972.4

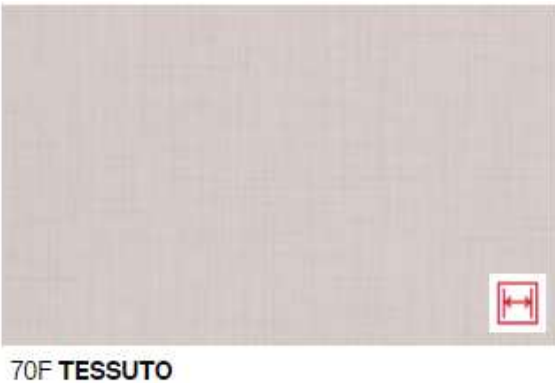



73Y **SELENE GRIS**



71A **GRIS GU**



910 **ROBLE NATURAL**



604 **ROBLE ENTABLILLADO**



399 **CEREZO LUNA**



375 **HAYA DAIMIEL**



222 **MAPLE BLANCO**



12G **LINO CANCÚN**



17G **PINO CERVINO**



4AE **ROBLE ETERNITY**



03C **NOGAL CANALETTO**



37E **RICHMOND PLUM**



5AE **NOGAL SLOW**



274B **ROBLE ROMANCE**



449B **OLMO GRACE**



452B **ROBLE COOPER**



94Y **IRON OAK**



008 **ROBLE BELLO**



80Y **ROBLE HÉRCULES**



97V **ROBLE COLORADO**



455B **NOGAL BOHEME**



251B **LECER**

GAMA ESTUDIO



464B **ARUBA NATURAL**



461B **ARUBA TOSTADO**



264B **NAVIA NATURAL**

Hasta final de existencias



265B **NAVIA BROWN**

Hasta final de existencias



475B **SAONA TRIGO**



476B **SAONA COGNAC**

BLANCO MEDIO	2440*1220*10/16/19/30mm 2850*2100*10/16/19/30mm	R. COLORADO	2850*2100*10/19/30mm
BLANCO LBE (BRILLO)	2850*2100*10/16/19mm	R. ETERNITY	2850*2100*10/19/30mm
BLANCO SR209 (BRILLO)	2600*2100*10/16/19mm	R. BELLO	2850*2100*10/19/30mm
GRIS AZULADO	2440*1220*16mm	R. ROMANCE	2850*2100*10/19/30mm
GRIS GU ANTRACITA	2440*1220*16/19mm 2850*2100*19mm	NOGAL SLOW	2850*2100*10/19/30mm
ALUMINIO 890	2440*1220*10/16/19mm 2850*2100*10/16mm	IRON OAK	2850*2100*10/19/30mm
LINO CANCUN	2850*2100*10/16mm 2600*2100*16/19mm	LEGER BOERAL	2850*2100*10/19/30mm
TESSUTO TEXTIL	2850*2100*10/16/19/30mm	OLMO GRACE	2850*2100*10/19/30mm
SELENE GRIS	2850*2100*10/16/19mm	R. COOPER	2850*2100*10/19/30mm
MAPLE BLANCO	2440*1220*10/16/19mm	RICHMOND PLUM	2850*2100*10/19/30mm
HAYA DAIMIEL	2440*1220*10/19mm 2600*2100*10/16/19mm 2850*2100*16/30mm	NOGAL BOHEME	2850*2100*10/19/30mm
CEREZO LUNA	2440*1220*10/16/19mm 2850*2100*10/16/19/30mm	NAVIA BROWN	2850*2100*10/19/30mm
NOGAL CANALETO	2440*1220*10/16mm 2600*2100*16mm 2850*2100*16/19mm	NAVIA NATURAL	2850*2100*10/19/30mm
PINO CERVINO	2600*2100*10/16mm 2850*2100*19mm	SAONA TRIGO	2850*2100*10/19/30mm
R. NATURAL	2440*1220*10/16/19mm	SAONA GOGNAC	2850*2100*10/19/30mm
R. HERCULES	2850*2100*10/19mm	ARUBA TOSTADO	2850*2100*10/19/30mm
R. ENTABLILLADO	2440*1220*10/19mm 2850*2100*10/16/19mm 2600*2100*10/16/19mm	ARUBA NATURAL	2850*2100*10/19/30mm

¡NOVEDAD!



06F Cemento Teide



435 Cerezo Canela Mesura



98Q Espiga Sal Textil



9AR Hickory Frida Boreal



84V Roble Denver Atlas



98Z Roble Ostippo Atlas

STOCK

FINSA
soluciones en madera

¡NOVEDAD!



273B Roble Verso Atlas



651B Azul Acero Bolero



653B Merino Bolero

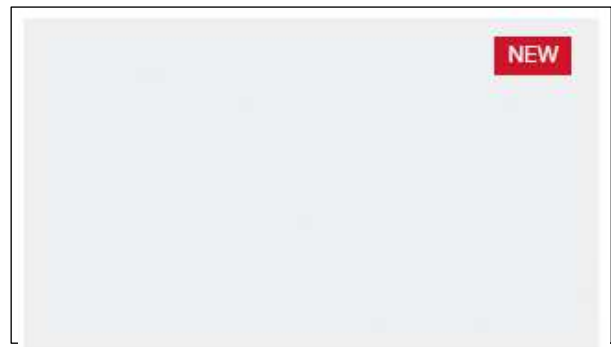

L001 Blanco Cuarzo Solid Matt

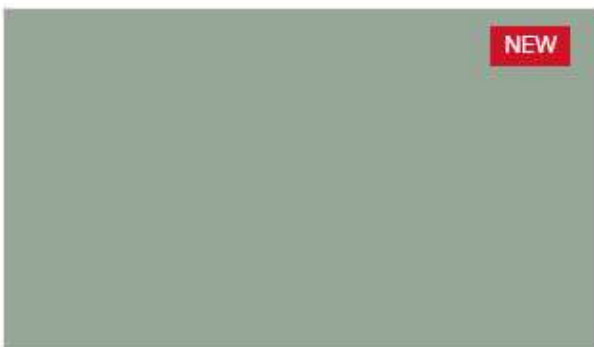

L005 Verde Java Solid Matt



L003 Gris Opalo Solid Matt

¡NOVEDAD!

STOCK

FINSA
soluciones en madera



693B Serenade Garden Calypeo



98P Olmo Bovary Atlas



2AR Japandi Natural Boreal



25V Roble Virginia Mesura

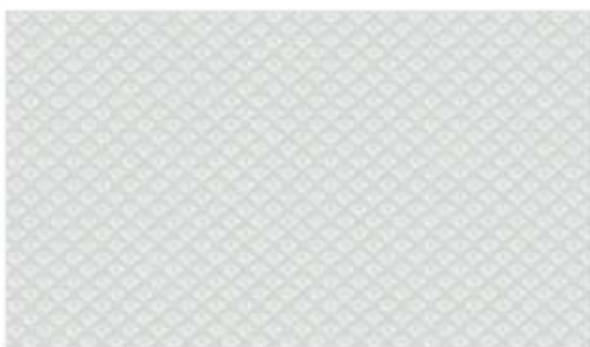

G001 Pure white Grip

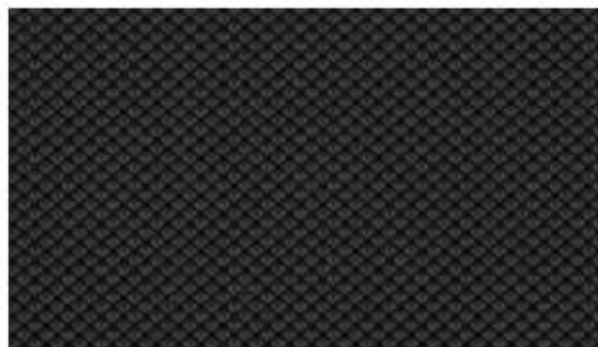

G003 Anthracite Grip

CEREZO CANELA MESURA (sobre aglomerado)	2850*2100*25mm	CEMENTO TEIDE (sobre aglomerado)	2850*2100*25mm
ESPIGA SAL TEXTIL (sobre aglomerado hidrófugo)	2850*2100*10/19mm	HICKORY FRIDA BOREAL	2850*2100*10/19mm
ROBLE DENVER ATLAS	2850*2100*10/19mm	ROBLE OSTIPPO ATLAS	2850*2100*10/19mm
ROBLE VERSO ATLAS (sobre aglomerado)	2850*2100*25mm	AZUL ACERO BOLERO	2850*2100*10/19mm
MERINO BOLERO	2850*2100*10/19mm	BLANCO CUARZO MATT	2850*1220*18mm
GRIS OPALO MATT	2850*1220*18mm	VERDE JAVA MATT	2850*1220*18mm
SERENADE GARDEN CALYPSO	2850*2100*10/19mm	OLMO BOVARY	2850*2100*10/19mm
JAPANDI NATURAL BOREAL	2850*2100*19mm	ROBLE VIRGINIA	2850*2100*10/19mm
PURE WHITE GRIP	2850*1220*16mm	ANTHRACITE GRIP	2850*1220*16mm

MELAMINAS KRONOSPAN

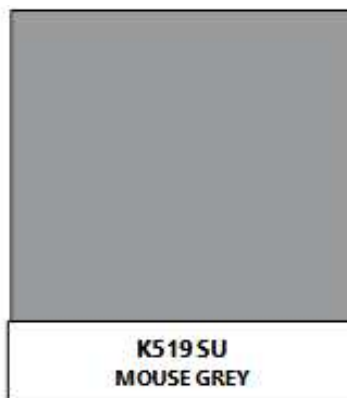
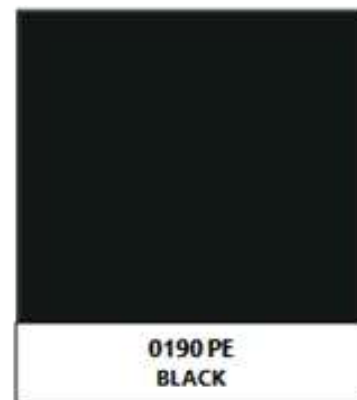
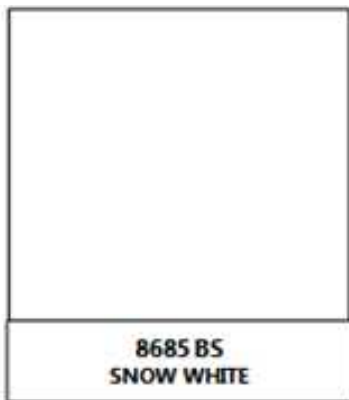

STOCK

kronospan



SNOW WHITE (8685 BS)	2800*2070*10/19mm	CASHMERE (5981 PE)	2800*2070*10/19mm
MOUSE GREY (K519 SU)	2800*2070*10/19mm	ANTHRACITE (0164 PE)	2800*2070*10/19mm
BLACK (0190 PE)	2800*2070*10/19mm	COTTA CREMONA (K2737 PW)	2800*2070*19mm
TORRO CREMONA (K2738 PW)	2800*2070*19mm	CANNOLO CREMONA (K2739 PW)	2800*2070*19mm
COAST EVOKE (K365 PW)	2800*2070*10/19mm	GOLD CRAFT (K003 PW)	2800*2070*10/19mm
GOLD BAROQUE (K535 RW)	2800*2070*10/19mm	RISTRETTO BAROQUE (K537 RW)	2800*2070*10/19mm
AMBER BAROQUE (K536 RW)	2800*2070*10/19mm	LIGHT ROCKFORD HICKORY (K085 PW)	2800*2070*19mm
NATURAL ROCKFORD HICKORY (K086 PW)	2800*2070*19mm	TEXTIL CANOVAS (5437 EE)	2800*2070*19mm

GAMA DUO

Se caracteriza por su flexibilidad e innovadora gama de diseños aportando soluciones a todo tipo de aplicaciones de mobiliario y creación de espacios en más de 80 países.

Diseños en melamina Gama DUO >Fantasías



Diseños en melamina Gama DUO >Maderas



Diseños en melamina Gama DUO >Unicolores

Para pedidos en tabletería suelta se aplica un incremento de 70€ por cada grosor y diseño diferente a modo de picking.

Observaciones: pueden ver los diseños de la Gama Duo actualizados en la página web de finsa

Dimensiones	Grosos (mm)
2850*2100	8
	10
	16
	18
	19
	22
	25
	30
	40

13. TIRAS CANTEADAS

Tablero compuesto por caras externas recubierto con papel decorativo impregnado con resinas melamínicas a ambos lados y canteado con PVC del mismo color. 1 lateral 1.2mm y el otro lateral 0.4mm

TIRA CANTEADA	MEDIDAS			
	2440*580*16mm	2440*330*16mm	2850*580*19mm	2530*1205*19mm
BLANCO SOFT	+	+		+
HAYA DAIMIEL	+	+		+
MAPLE BLANCO	+			
ROBLE ENTABLILLADO	+	+		+
ROBLE NATURAL	+			
ROBLE HERCULES	+			
TEXTIL TESSUTO	+			+
GRIS ALUMINIO	+	+		
NOGAL CANALETO	+			
LINO CANCUN	+			+
PINO CERVINO	+			
SELENE GRIS	+			
CEREZO LUNA	+	+		

STOCK

TABLEX

TABLEX CRUDO

2440*1220*2.5mm

2440*1220*03mm

2440*1220*4.8mm



MODELO	MEDIDAS
ALUMINIO-ROBLE ENTABLILLADO	2440*1220*04mm
BLANCO SOFT 2 CARAS	2440*1220*04mm
BLANCO LISO BLANCO-GRIS	2440*1220*04mm
NOGAL CANALETTO -ROBLE ENTABLILLADO	2440*1220*04mm
ROBLE ENTABLILLADO-CEREZO	2440*1220*04mm
ROBLE ENTABLILLADO-HAYA	2440*1220*04mm

TABLEX SOPORTE DM

BLANCO 2440*1220*4mm

14. RECHAPADO Y CONTRACHAPADO

TABLEROS RECHAPADOS CHAPA NATURAL

Tablero de partículas de madera de formación en tres capas aglomerado con resinas sintéticas mediante prensado plano a alta temperatura y lijado. Calidad estándar 1ª/2ª Medidas 2440*1220.

Soporte sobre aglomerado	GROSOR			
CHAPA	04	11	16	19
HAYA BLANCA	+	+		
HAYA VAPORIZADA	+	+	+	+
ROBLE	+	+	+	+
SAPELLY	+	+	+	+
PINO VALSAIN	+	+	+	+

Otros soportes bajo pedido

CANTOS

CANTOS SINTÉTICOS



Disponemos en nuestros almacenes de cantos sintéticos para nuestra gama de stock de melamina.

Los cantos que tenemos en stock son de ancho 22mm y con la posibilidad de ser precolados o sin cola.

CANTOS PVC

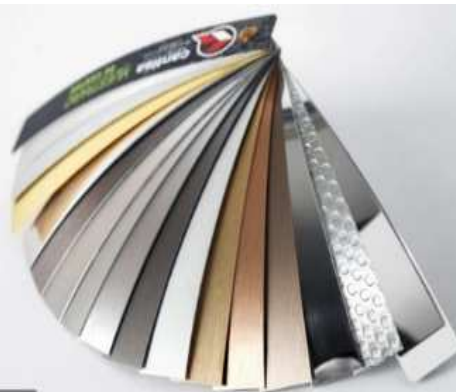

Disponemos de cantos PVC en varios espesores; 0.4mm, 0.8mm y 1mm.

En anchos de 22mm y 35mm. Disponemos de los modelos acorde con nuestra gama de melaminas.

Posibilidad de adquirir diseños bajo pedido.

CHAPA



Las chapas que ofrecemos para nuestros tableros rechapados son de ancho 22mm (sin cola o preencolados).

También disponemos de chapas con anchos de 240mm.

TABLERO FENOLICO CONTRACHAPADO ANTIDESLIZANTE “CARROCERÍAS”

Madera contrachapada encolada con cola fenólica. Una cara de deslizamiento está recubierta con una película fenólica con el panel marrón y liso en la cara trasera.

La base está hecha de madera contrachapada de abedul capa cruzada con las caras opciones II según la norma EN 635-2. Su densidad oscila entre 640 y 700 kg/m³.

TABLERO EN MATERIAL: ABEDUL

2500*1525/1250*9mm

2500*1525/1250*12mm

2500*1525*15mm

2500*1525*18mm

2500*1525*21mm

2500*1525/1250*30mm



TABLERO EN MATERIAL CHOPO

2500*1250*18mm



STOCK

CONTRACHAPADO CALABO

MEDIDAS

2500*1220*03mm
2500*1220*04mm
2500*1220*05mm
2500*1220*07mm

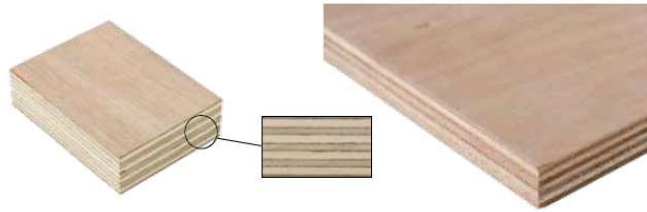

CONTRACHAPADO FENÓLICO

MEDIDAS

OKUMEN WBP 2500*1220*10mm
OKUMEN WBP 2500*1220*12mm
OKUMEN WBP 2500*1220*15mm
OKUMEN WBP 2500*1220*18mm
OKUMEN WBP 2500*1220*20mm



CONTRACHAPADO FENÓLICO ENCOFRAR CON FILM

MATERIAL

2500*1250*18mm
2500*1250*21mm
2500*1250*24mm



STOCK

CONTRACHAPADO FENÓLICO EMBALAJE C/C+ PINO ELIOTTI



MATERIAL

2500*1250*15mm

2440*1220*18mm

CONTRACHAPADO FENÓLICO ABEDUL



MATERIAL

2500*1250*12mm

PANADERIA

Consultar Disponibilidad.



NOWAKI CAMPER PANEL

Tablero ultraligero específicamente pensado para la camperización.

Está hecho de madera Paulownia, que tiene muchas ventajas para aplicaciones de mobiliario y revestimientos interiores.

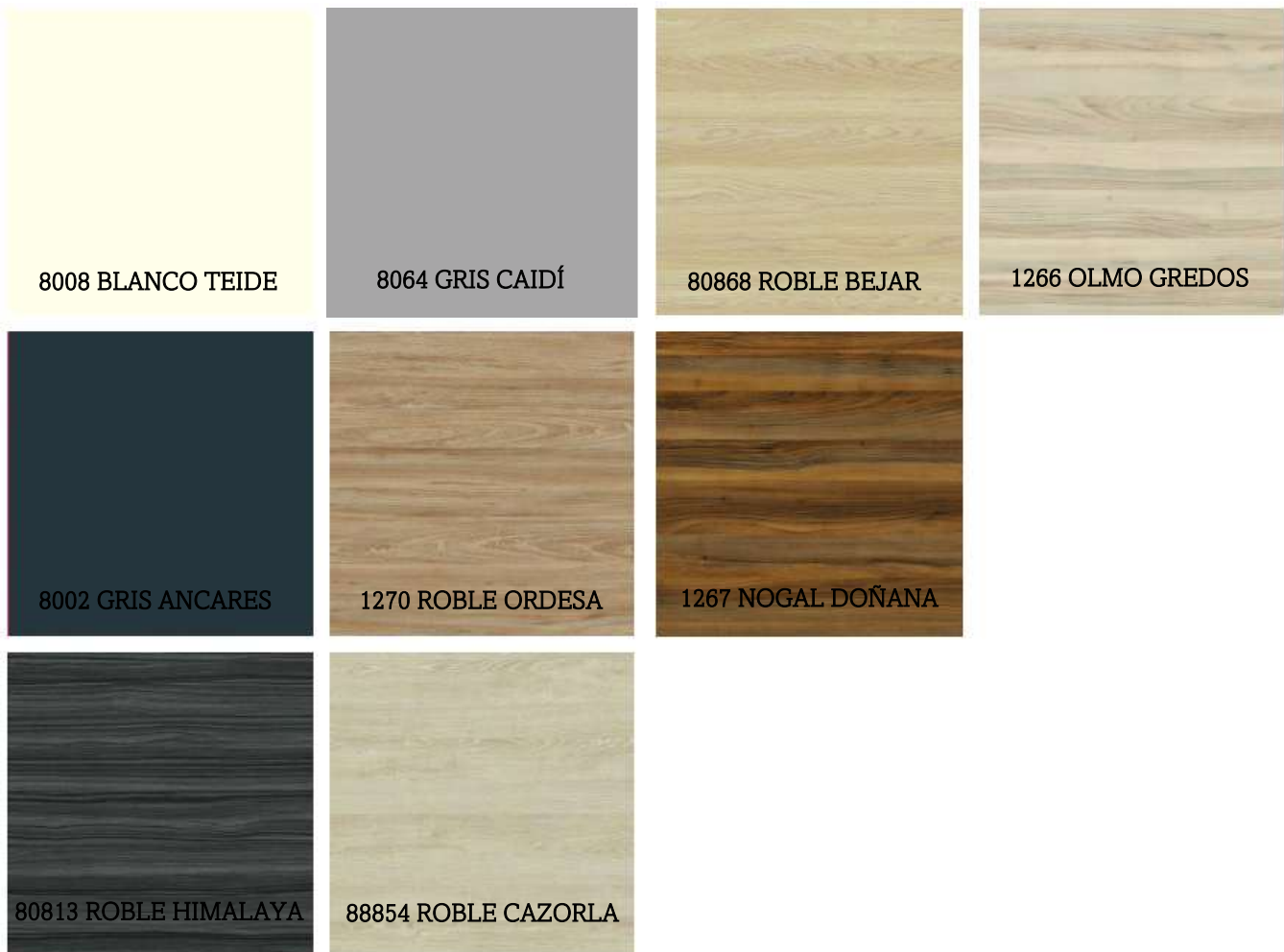

CARACTERÍSTICAS:

- Panel ultraligero de madera de Paulownia con recubrimiento decorativo HPL
- Formatos: 2440*1220*15mm
- Aplicaciones: Panelados, frentes y mobiliario

15. TABLERO ALISTONADO

MONOCAPA

TABLERO ALISTONADO PINO LAMA ENTERA

MATERIAL

ENTERO RADIATA 2400*1220*22 mm

ENTERO RADIATA A/A 2450*1220*18 mm

ENTERO RADIATA A/AB 2400*1220*30 mm

INSIGNIS 1° A/B 2500*1220*40 mm

PINO ROJO LIMPIO LAMA 20
3660*1220*25mm

con cola fenólica que sirve para exterior



TABLERO ALISTONADO ABETO

MATERIAL

2250*1200*10mm

2250*1200*24mm

2500*1200*14mm

2750*1200*10mm

2750*1200*21mm

2750*1200*24mm

2750*1200*27mm

2750*1200*35mm



TABLERO ALISTONADO PINO FINGER

MATERIAL

FINGER JOINT 2440*1220*22mm

FINGER JOINT 2440*1220*30mm

FINGER JOINT 2440*1220*18mm



TABLERO ALISTONADO ROBLE

MATERIAL

ROBLE FINGER 3300*1220*19mm

ROBLE FINGER 3300*1220*32mm

ROBLE FINGER 3300*1220*42mm



TABLERO ALISTONADO HAYA

MATERIAL

HAYA VAPORIZADA FINGER 3300*1220*19 mm

HAYA VAPORIZADA FINGER 3300*1220*32 mm

HAYA VAPORIZADA FINGER 3300*1220*42 mm



STOCK

TABLERO ALISTONADO IROKO

MATERIAL

IROKO FINGER 3300*1220*19 mm

IROKO FINGER 3300*1220*32 mm

IROKO FINGER 3300*1220*42 mm



TRICAPA

TABLERO ALISTONADO TRICAPA ABETO



MEDIDAS

2500*2050*19 mm 5000*2050*19mm

2500*2050*27mm 5000*2050*27mm

2500*2050*35mm 5000*2050*35mm

TABLERO DE ENCOFRAR TRICAPA



MATERIAL

2000*500*27mm

Consultar Disponibilidad.

PARKLEX PRODEMA
ABET LAMINATI®

16. TABLERO COMPACTO

COMPACMEL PLUS

COMPACMEL PLUS es un tablero compacto de fibras de madera recubierto con papel decorativo impregnado con resinas melamínicas.

Ofrece un buen comportamiento en aplicaciones de interior que requieren una exposición en condiciones de humedad elevada y persistente en el

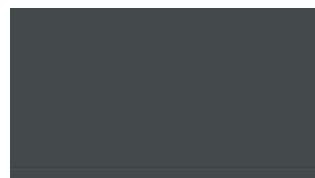

71A- GRIS GU
Soft III

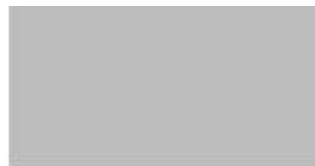

U12- NATURAL GREY
Soft III



139 AZUL EO
Soft III



78E- WHITE SR209
Soft III

Consultar Disponibilidad.

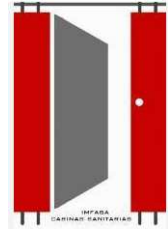

CABINAS FENOLICAS SANITARIAS

IMFASA se dedica a la fabricación y montaje de cabinas sanitarias fenólicas, taquillas guardarropa, bancos y encimeras de vestuario fenólicas; así como la mecanización de productos en compacto fenólico y aplacados de laminados de alta presión (HPL).

Utilizan materiales compactos de alta resistencia y componentes inoxidables.

PRODUCTOS:

1. CABINAS SANITARIAS
2. ENCIMERAS FENÓLICAS
3. BANCOS DE VESTUARIO
4. TAQUILLAS GUARDARROPA
5. REVESTIMIENTOS FENÓLICOS

Para más información pueden visitar la página web

<https://www.cabinasfenolicasimfasa.es/>



17. MARCOS

PREMARCOS

PREMARCO MULTICABECERO

	Medidas mm
Para puerta: 625/725/825mm	40*60*2040mm
	40*70*2040mm
	40*80*2040mm
	40*90*2040mm
	40*100*2040mm
	40*110*2040mm
	40*120*2040mm
	40*130*2040mm
	40*140*2040mm
	Para puerta doble: 1470mm



Observaciones: Todos los premarcos vienen desmontados

PREMARCO PARA PLADUR

	Medidas mm
Para puerta: 625/725/825mm	40*80*2040mm
	40*100*2040mm



STOCK

CERCOS DIRECTOS

	MEDIDAS m/m	CABECERO
GALCE 35	2030*70*57	625
		725
		825
	2030*57*70	625
		725
		825
	2030*57*90	625
		725
		825
	2030*57*115	625
		725
		825
GALCE 45	2030*70*90	825
	2030*70*145	825

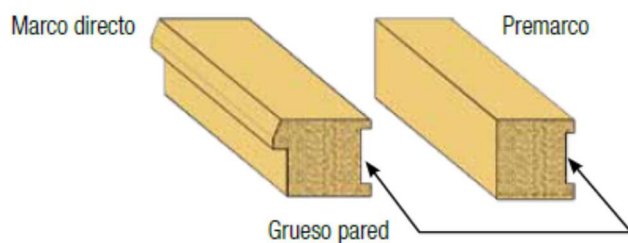

LARGUERO ALIST. ABETO

2700*60*40

ARMAZONES PARA PUERTA CORREDERAS

MEDIDAS		
Armazones para enlucir con yeso	Medida puerta	Huevo total ancho x alto
600*2020/2100* 90/108	625	1315*2110
700*2020/2100* 90/108	725	1515*2110
800*2020/2100* 90/108	825	1715*2110
900*2020/2100* 90/108	925	1915*2110
1000*2020/2100* 90/108	1025	2115*2110

VERSIÓN ENLUCIDO

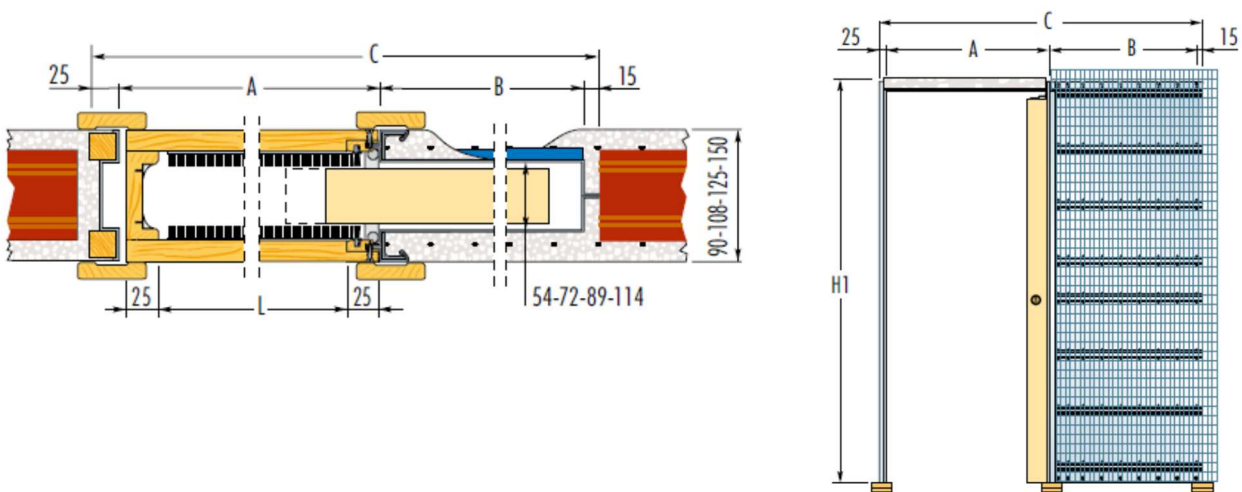

Material		
Armazones para cartón yeso	Medida puerta	Huevo total ancho x alto
600*2020* 100	625	1297*2105
700*2020* 100	725	1497*2105
800*2020* 100	825	1697*2105
900*2020* 100	925	1897*2105
1000*2020* 100	1025	2097*2105

VERSIÓN CARTÓN YESO

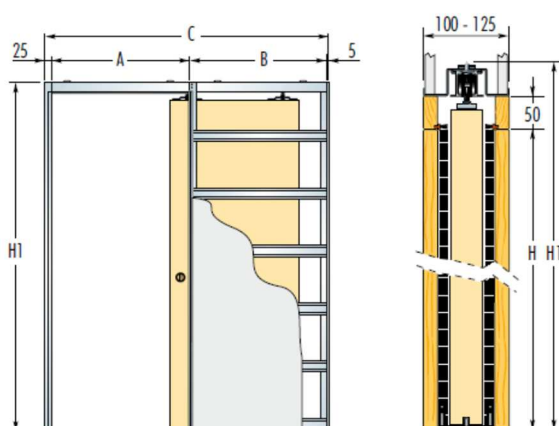

ACCESORIOS ARMAZONES

KIT CORREDERAS MDF

KIT 90/ 110

PRELACADO

LACADO

SAPELY BARNIZADO y S/B

ROBLE BARNIZADO y S/B

HAYA BARNIZADO y S/B



STOCK

18. PUERTAS

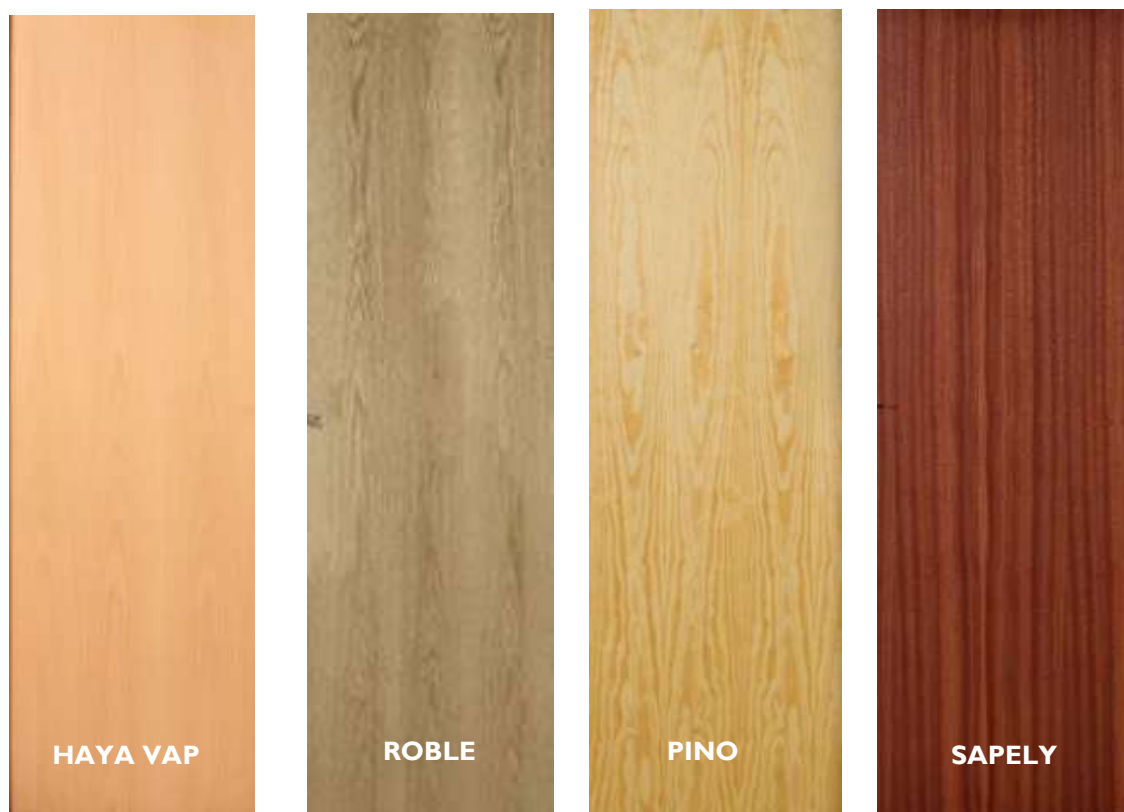

PUERTAS LISAS C/O	MEDIDAS	BARNIZADAS	S/B
PINO	2030*625/725/825*35	+	+
SAPELY	2030*625/725/825*35	+	+
ROBLE	2030*625/725/825*35	+	
HAYA VAP.	2030*625/725/825*35	+	

PUERTA DM CRUDO 7 mm

CIEGA 2030*725*35

CIEGA 2030*825*35

PUERTAS EN KIT

STOCK

puertas



V3

Fresado pico-gorrión



V4

Fresado pico-gorrión

F04
LACADA

catálogo





LISA LACADA



V1

V4

H04 LACADA



V3

Fresado pico gorrón

V4

Fresado pico gorrón





H00 LACADA



V3
Fresado pico gorrón

V4
Fresado pico gorrón



F02
LACADA

catálogo





21513
LACADO BLANCO



LACADO BLANCO 21500





20101
LACADO BLANCO



LACADO BLANCO 20100





216

LACADO BLANCO



LACADO BLANCO

212





3203
LACADO BLANCO



LACADO BLANCO

3212





LISA



V1
Roble
Haya vaporizada
Sapelly
Pino país



V3
Roble
Haya vaporizada



V4
Roble
Haya vaporizada



V3
Roble



V4
Roble

DECO TS

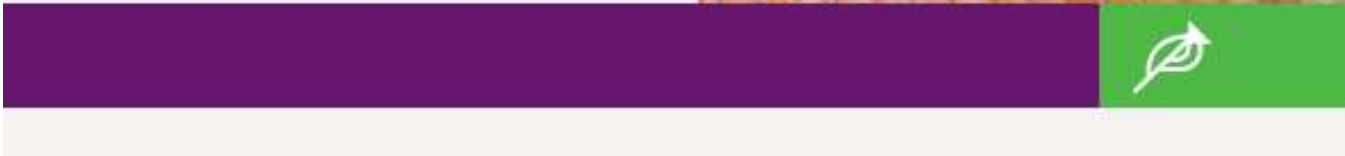

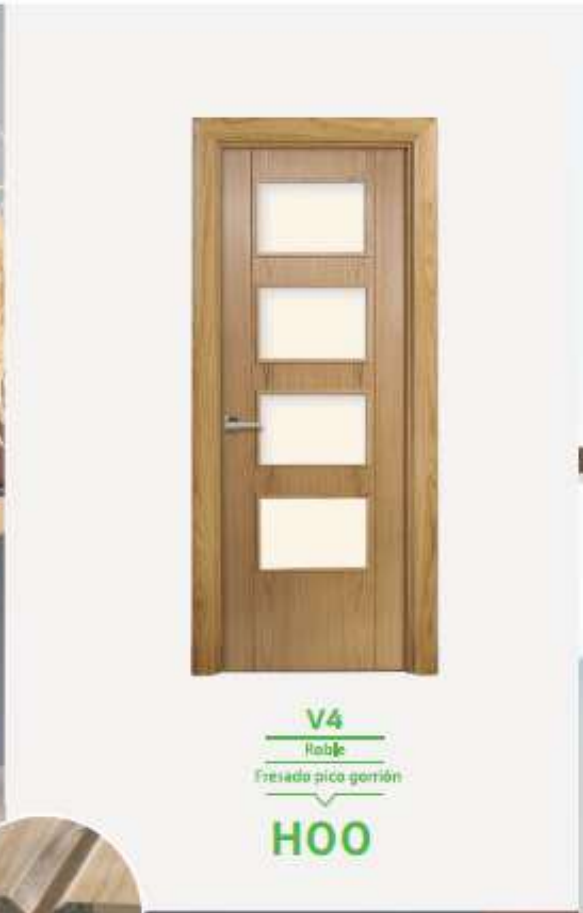

V4
 Roble
 Fresado pico gorrón
H00



V3
 Roble
 Haya vaporizada
 Fresado pico gorrón

V4
 Roble
 Haya vaporizada
 Fresado pico gorrón



F04





V4
Roble
Fresado pico gorrón

H04
ROBLE



catálogo



DISPONIBILIDAD DE CATALOGO
COMPLETO EN PDF

PUERTAS DE MELAMINA



X1000 Talcum*



X1000 Golden*



Roble Urban



Roble Finlandés

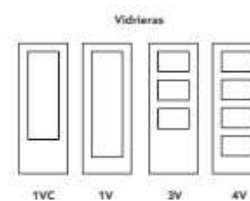
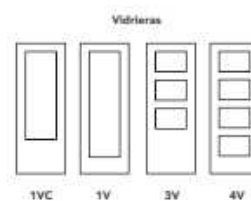
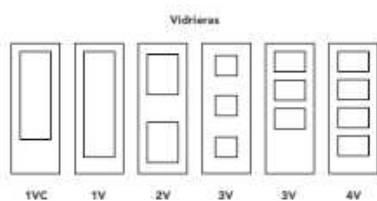

Puertas laminadas

Más fácil de instalar y ajustar gracias a su ligereza y más estable a largo plazo, lo que aumenta la durabilidad de los herrajes.
Reducción acústica, certificada mediante ensayos normalizados, de 23 dB sin accesorios adicionales.

- 1 Poliestireno
- 2 Aglomerado
- 3 MDF Hidrófugo





Fresno Eslovenia



Nogal Arena



**Roble Nature
veta vertical**

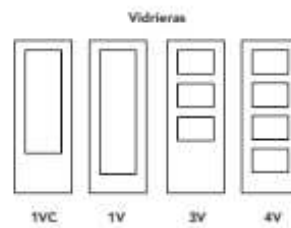
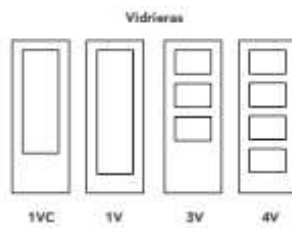
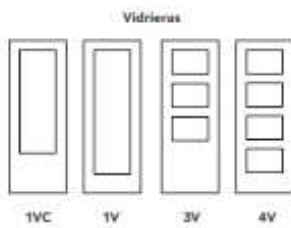

Puertas laminadas

- Puerta de aglomerado maciza de 35mm.
- Tablero de 650kg/m³ de 35mm laminado en ambas caras
- Diseño decorativo con impregnación especial y acabado con poro natural
- Canteado a 4 lados

Roble Nature
Vidrieras

1VC 1V 3V 4V

Consultar Disponibilidad.

PUERTAS MACIZAS

PUERTAS ENTRADA

SERIE 200



MODELO E214



MODELO E215



MODELO E216



MODELO E217



MODELO E311



MODELO E317



MODELO E315



MODELO E307



MODELO E304



MODELO E305



MODELO E401



MODELO E402



MODELO E409



MODELO E414



MODELO E411



MODELO P501



MODELO P506



MODELO P513



MODELO P504



MODELO P510



MODELO P512

Consultar Disponibilidad.

GRUPO DAYFOR
UNA PUERTA
al futuro

PUERTAS GRUPO DAYFOR

SERIE LAMINADOS: alternativas a la madera natural

- Fabricación de puertas técnicas de alta calidad para obra pública
- Solución práctica con la posibilidad de fabricar puertas de paso, entrada, resistentes al fuego, acústicas, armarios, etc.
- Personalización estética



Consultar Disponibilidad.



PUERTAS PLEGABLES PVC

Se trata de puertas fabricadas en PVC de alta calidad, serigrafiadas en cuatricromía y lacadas

SERIE VINILO

MODELO BERNA



Colores disponibles



Blanco



Roble



Sapelly



Nogal



Haya Vap

MODELO NIZA



Consultar Disponibilidad.



SERIE MADERA NATURAL

Esta gama de la colección está realizada íntegramente en madera contrachapada natural barnizada y con sus componentes en madera maciza

Colores disponibles



Lacado
Blanco



Roble



Sapelly

MODELO MILÁN



MODELO SIENA



PUERTAS DE ALUMINIO

1. La puerta de aluminio STRUGAL no se hinchan por efecto de la humedad ni se deterioran por el contacto del agua.
2. Son más resistentes al paso del tiempo. No se estropean ni descomponen.
3. Se limpian fácilmente.
4. Fáciles de montar y desmontar por cualquier usuario.
5. Se pueden colocar tanto en premarcos de aluminio como de madera.
6. Pueden ajustarse fácilmente a las posibles dilataciones de la obra o del premarco.
7. Permiten un diseño totalmente personalizado.
8. Son 100% resistentes a la carcoma, las termitas y cualquier insecto.
9. Se pueden suministrar con acabado antibacteriano.
10. Mejoran la eficiencia energética de la vivienda y contribuyen a la reducción de CO₂.
11. Ofrecen un notable incremento en seguridad.

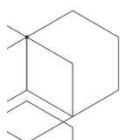

PUERTAS DE
ALUMINIO

PORTES EN ALUMINIUM



Consultar Disponibilidad.

STRUGAL

PUERTAS DE PASO



STRUGAL A 100 C



STRUGAL A 100 1VAL



STRUGAL A 100 3VA



STRUGAL A 100 4VA



STRUGAL
A 200 4FH1



STRUGAL
A 200 4FH1/V



STRUGAL
A 200 2FH



STRUGAL
A 200 2FH/V



STRUGAL
A 200 4FH2



STRUGAL
A 200 4FH2/V

Consultar Disponibilidad.

STRUGAL

PUERTAS DE EXTERIOR



STRUGAL A 300 4IH1



STRUGAL A 300 4IH1/V



STRUGAL A 300 4IH2



STRUGAL A 300 4IH2/V



STRUGAL A 600 3VA



STRUGAL A 600 4VE

Fresado
Fresagen



Incrustación
Incrustação



 Incrustación fuera de stock.
Incrustação fuera de stock.



ACABADOS STOCK. ACABAMENTOS STOCK.

Ver disponibilidad. Ver disponibilidade.



Consultar Disponibilidad.

Dierre

PUERTAS DE ALTA SEGURIDAD



ACORAZADAS SPARTA 5

DIVISIÓN DE ESPACIOS



ESTRUCTURA P20



VITRINAS IKS



Consultar Disponibilidad.



mondragon



Cada producto es individual y hecho a medida

Para más información pregunte en nuestras oficinas o visitando página web:

<https://www.mondragonline.com/>

MANIVELAS



R-130 INOX



RC 559N



R-136 LATÓN



RCC 220



R-130N NEGRA



R-430



RCC 120



RI 2025

STOCK



R-530



RC530



R-530N



RC240



CASTELLON



LLUNA

MANILLON MOD RC534



MANILLON MOD RC244



KIT TIRADOR UÑERO MOD 2003	
CON PICO LORO	SIN PICO LORO
LATON	LATON
INOX	INOX
NEGRO	NEGRO

POSIBILIDAD DE SER CUADRADO O REDONDO

19. ARMARIOS

ARMARIOS CON PUERTAS ABATIBLES



STOCK

Lacado liso

Composición:

- Módulos abatibles de 1000 mm
- Hojas de armario abatible de 500 mm
- Costados decorativos
- Zócalo

Opciones:

- Módulos abatibles de 400 / 500 / 800 / 1000 mm
- Hojas de 400 / 500 mm

Ver todas las posibles combinaciones y opciones en las páginas 14 y 15.

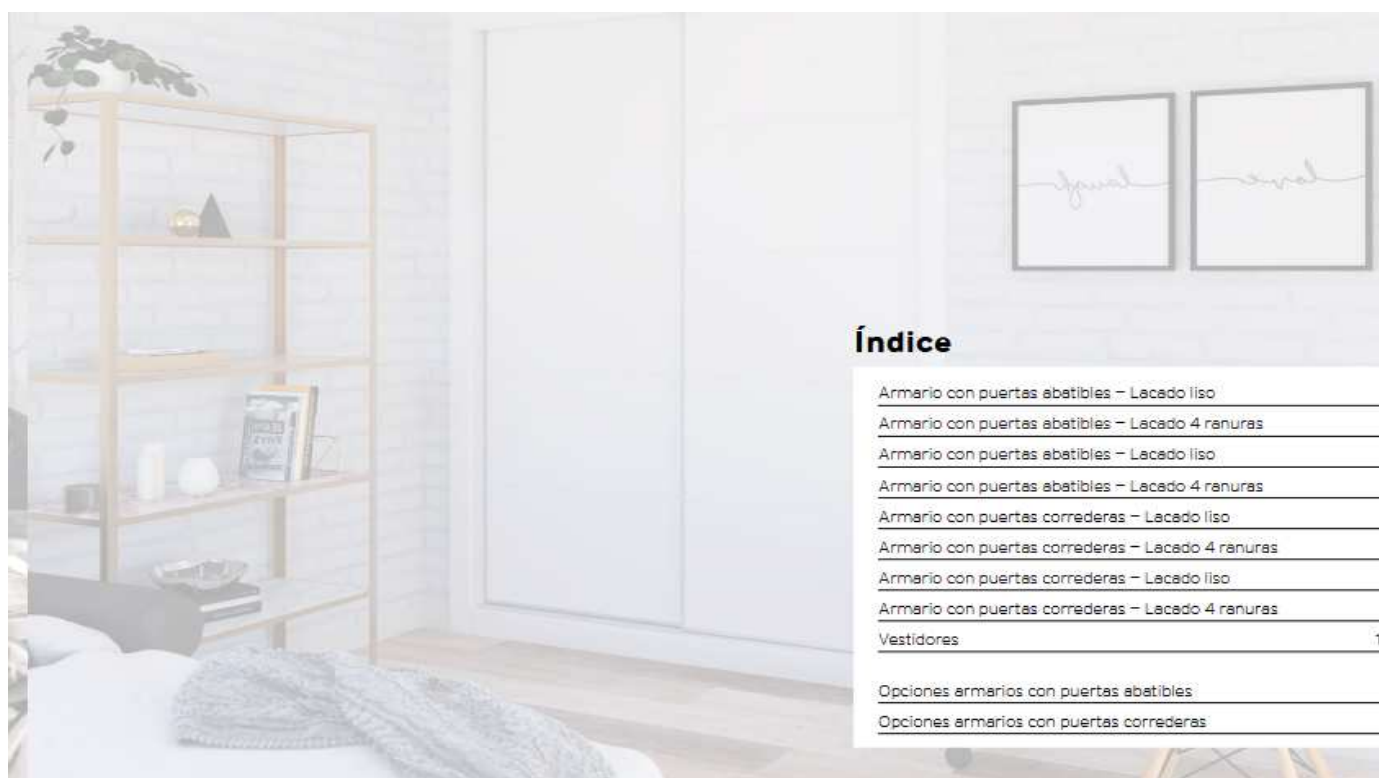

Índice

Armario con puertas abatibles – Lacado liso	
Armario con puertas abatibles – Lacado 4 ranuras	
Armario con puertas abatibles – Lacado liso	
Armario con puertas abatibles – Lacado 4 ranuras	
Armario con puertas correderas – Lacado liso	
Armario con puertas correderas – Lacado 4 ranuras	
Armario con puertas correderas – Lacado liso	
Armario con puertas correderas – Lacado 4 ranuras	
Vestidores	12
Opciones armarios con puertas abatibles	
Opciones armarios con puertas correderas	

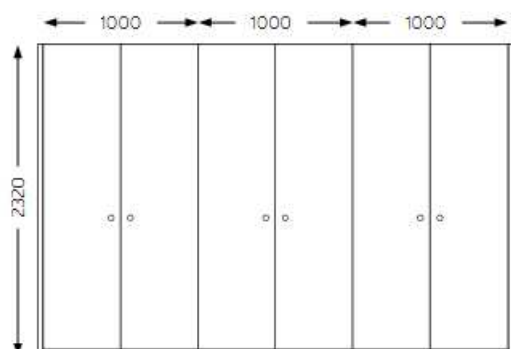



Armario con puertas abatibles

Lacado liso

Composición:

- Módulos abatibles de 800 mm
- Hojas de armario abatible de 400 mm
- Tapajuntas, montante y zócalo

Opciones:

- Módulos abatibles de 400 / 500 / 800 / 1000 mm
- Hojas de 400 / 500 mm

Ver todas las posibles combinaciones y opciones en las páginas 14 y 15.

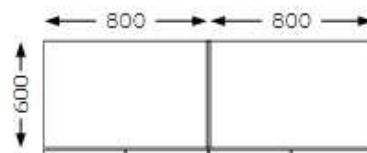
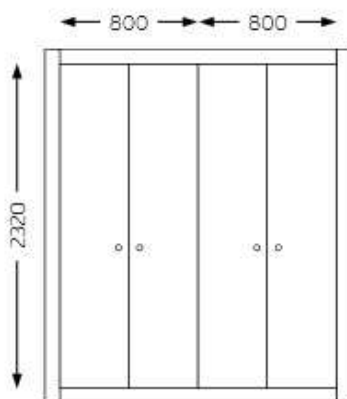



Armario con puertas abatibles

Lacado 4 ranuras

Composición:

- Módulos abatibles de 1000 mm
- Hojas de armario abatible de 500 mm
- Costados decorativos
- Zócalo

Opciones:

- Módulos abatibles de 400 / 500 / 800 / 1000 mm
- Hojas de 400 / 500 mm

Ver todas las posibles combinaciones y opciones en las páginas 14 y 15.

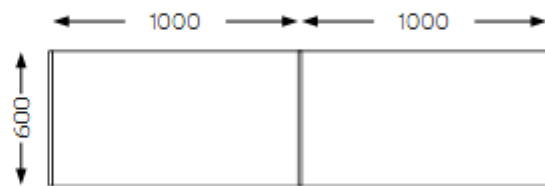
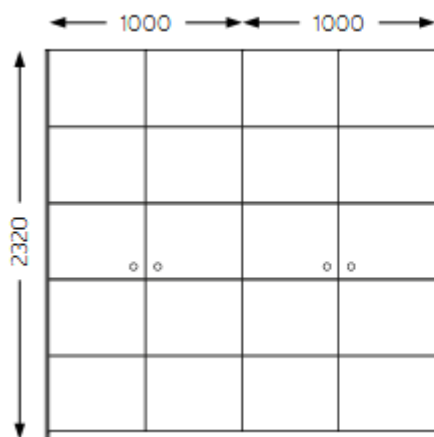

ARMARIO PARA PUERTA CORREDERA



Lacado liso

Composición:

- Módulo corredera de 2400 mm
- Hojas de armario corredera de 800 mm
- Balda maletero y baldas estantes
- Tapajuntas, tapeta lateral de cierre, montante y zócalo

Opciones:

- Módulos corredera de 1600 / 2000 / 2400 mm
- Hojas de 800 / 1000 mm

Ver todas las posibles combinaciones y opciones en las páginas 14 y 15.

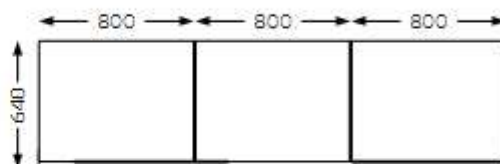
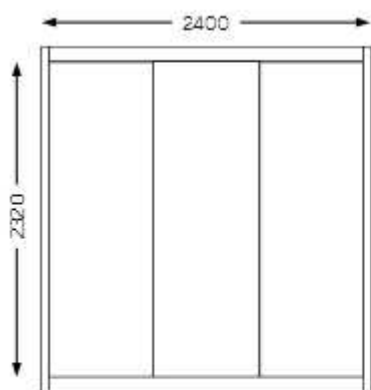



Lacado 4 ranuras

Composición:

- Módulo corredera de 2400 mm
- Hojas de armario corredera de 800 mm
- Tapetas laterales de cierre, montante y zócalo
- Costados decorativos con tapetas especiales

Opciones:

- Módulos corredera de 1600 / 2000 / 2400 mm
- Hojas de 800 / 1000 mm

Ver todas las posibles combinaciones y opciones en las páginas 14 y 15.

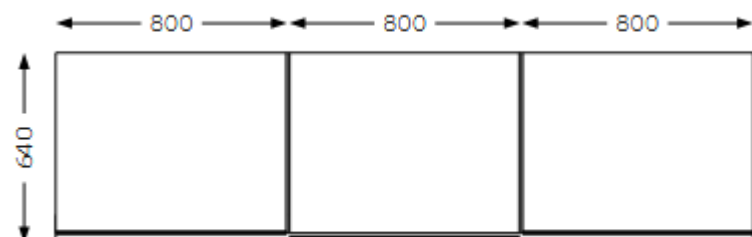
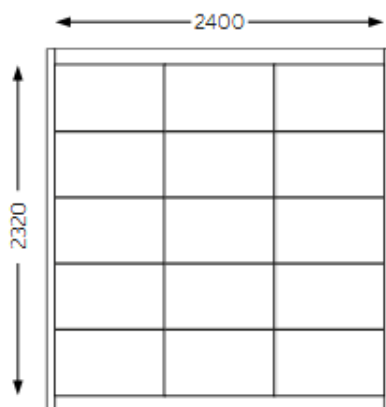



Armario con puertas correderas

Lacado 4 ranuras

Composición:

- Módulo corredera de 1600 mm
- Hojas de armario corredera de 800 mm
- Tapajuntas, tapeta lateral de cierre, montante y zócalo

Opciones:

- Módulos corredera de 1600 / 2000 / 2400 mm
- Hojas de 800 / 1000 mm

Ver todas las posibles combinaciones y opciones en las páginas 14 y 15.



15.

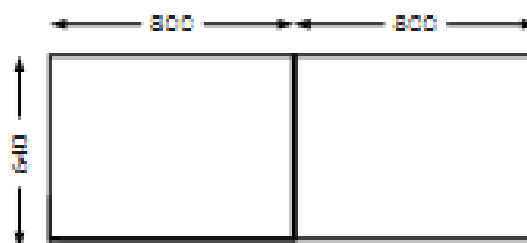
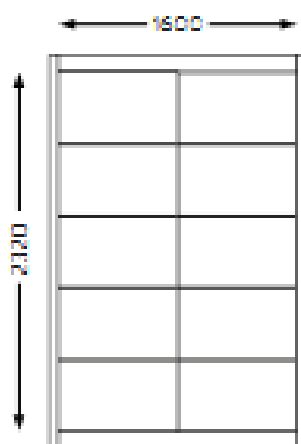

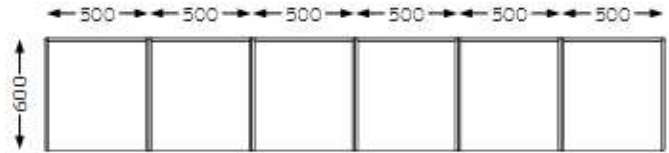
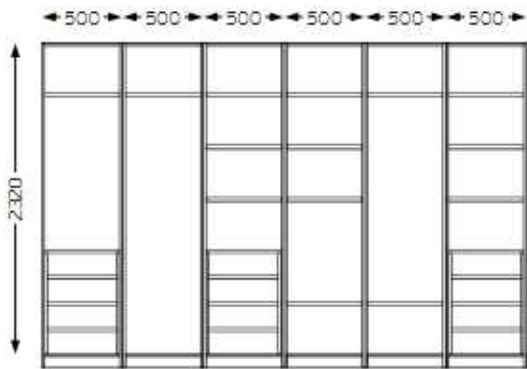



Vestidor

Composición:

- Módulos de 800 mm
- Cajonera 4 cajones de 700 mm
- Divisor vertical
- Barras de colgar
- Baldas maletero y baldas estantes

Opciones:

- Módulos de 400 / 500 / 800 / 1000 mm
- Hojas de 400 / 500 mm

Ver todas las posibles combinaciones y opciones en las páginas 14 y 15.

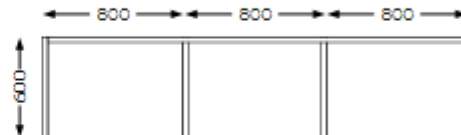
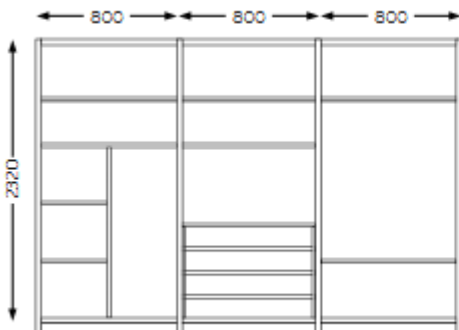

[Consultar Disponibilidad.](#)

ARMARIOS CORREDERAS

Sistema de puertas deslizantes

Su principal ventaja es el ahorro de espacio en la apertura de las puertas.

Disponible en dos y tres carriles, facilitando el acceso al interior gracias a la apertura frontal en 2/3 de la superficie total de los paneles,



ARMARIOS ABATIBLES

El sistema tradicional de apertura es un clásico actualizado gracias a un sinfín de diseños

Se encuentra disponible en dos espesores: 10mm 16mm.



INTERIORES ABATIBLE

Es aquí donde cada usuario debe elegir la distribución que mejor se adapte a su forma de sentir el orden, por nuestra parte le facilitamos la posibilidad de hacer realidad cualquier fantasía y de dotarla, a la vez, de la belleza que aporta una amplia gama de acabados.



PERFILERÍA Y COMPLEMENTOS DE ALUMINIO PARA ARMARIOS

CORREDERO KIT GUIAS			
DISEÑOS	MEDIDAS		
PINO SIN BARNIZAR	2 METROS	3 METROS	4 METROS
BLANCO CHAMONIX			
NEGRO MATE			
PLATA MATE			
CORREDERO KIT TIRADORES			
KIT TIRADOR KP-TR 10mm (MIN)	BLANCO CHAMONIX		
	NEGRO MOKKA		
	PLATA MATE		
KIT TIRADOR KP-TR 10mm	PLATA MATE		
CORREDERO KIT TIRADORES			
KIT TIRADOR KP-TR 16mm (MIN)	BLANCO CHAMONIX		
	NEGRO MOKKA		
	PLATA MATE		
KIT TIRADOR KP-TR 16mm	ROBLE SIN BARNIZAR		
	PLATA MATE		
	PINO SIN BARNIZAR		

COMPOSICIÓN DEL KIT DE PUERTA:

- 2 RUEDAS INFERIORES
- 2 RUEDAS SUPERIORES
- 2 PERFILES TIRADORES (2x2.6m)
- 1 JUEGO GUÍAS (SUPERIOR / INFERIOR)



TABLERO NO INCLUIDO

Consultar Disponibilidad.

Inper

CAJONERAS



- Posibilidad de hasta 7 cajones
- Mínimo Ancho x Fondo: 40x40
- Máximo Ancho x Fondo: 80x60

Para más información consultar en nuestras oficinas

20. TAPETAS MDF

TAPETAS MDF

DISEÑOS		MEDIDAS
PRELACADO		70*10
LACADO ALEMAN		
SAPELY	BARNIZADO	70*12
	SIN BARNIZAR	
ROBLE	BARNIZADO	70*16
	SIN BARNIZAR	
PINO	BARNIZADO	90*10
	SIN BARNIZAR	
HAYA VAP.	BARNIZADO	90*12
	SIN BARNIZAR	
HAYA VAP.	BARNIZADO	90*16
	SIN BARNIZAR	

TAPETA DM-CHAPA

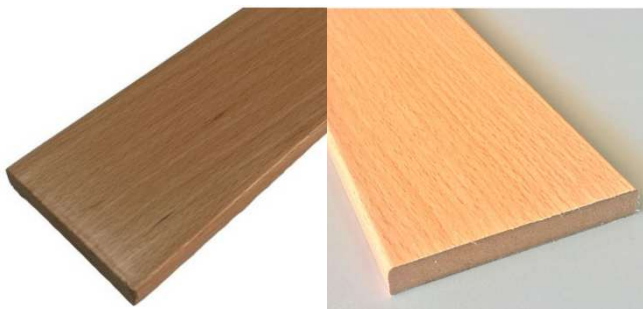

MOLDURA DM-CHAPA



STOCK

BATIDEROS MDF



DISEÑOS	
PRELACADO	
LACADO ALEMAN	
SAPELY	BARNIZADO
	SIN BARNIZAR
ROBLE	BARNIZADO
	SIN BARNIZAR
PINO	BARNIZADO
	SIN BARNIZAR
HAYA VAP.	BARNIZADO
	SIN BARNIZAR

MEDIDAS	
60*20	60*30
70*20	70*30
80*20	80*30
90*20	90*30
100*20	100*30
110*20	110*30
120*20	120*30
130*20	130*30
140*20	140*30
150*20	150*30

Posibilidad de traer extensible y con goma bajo pedido

21. VENTANAS

Material: La materia utilizada para su fabricación es 100% madera natural (maciza o laminada), renovable, inagotable y su consumo favorece la forestación local y protección del medio ambiente.

La ventana de madera proporciona altos niveles de aislamiento térmico.

Naturaleza y técnica: La fusión de la naturaleza y la técnica hacen que esta ventana adquiera grandes prestaciones, sometiéndola periódicamente a pruebas de laboratorio para asegurar su perfecta estanqueidad y cumplimiento de las normativas.



VENTANAS **W-JART**



Consultar Disponibilidad.



VENTANAS DE MADERA



SERIE 69



SERIE 89

VENTANAS MIXTAS



SERIE HERMOD 70



SERIE ASTRO 10 PLUS



SERIE ASTRO 9 PLUS

AHORRO ENERGETICO



La madera por sí misma es una materia con baja termoconductividad con lo cual es altamente eficaz contra la formación de condensación de agua, aislamiento térmico y acústico.

Si a esta ventana de madera le ponemos el cristal adecuado podemos alcanzar un coeficiente de transmitancia térmica de $UW=0,8 \text{ Wm}^2\text{K}$. Con lo cual se convierte en cerramiento ideal para la construcción de Passivhaus, obteniendo un bajo consumo de energía, una menor contaminación del medio ambiente y un considerable ahorro económico.

Nome progetto:	isoterme	Temperatura interna:	20.00 °C		Nome progetto:	isoterme	Temperatura interna:	20.00 °C
Visualizzazione:	Report	Temperature esterna:	0.00 °C		Visualizzazione:	Report	Temperature esterna:	0.00 °C
Trasmittanza (U):	0.936 W/m²K	Umidità interna:	40.00 %		Trasmittanza (U):	1.017 W/m²K	Umidità interna:	40.00 %
Conduttanza 2D (Lf2D):	0.393 W/mK				Conduttanza 2D (Lf2D):	0.246 W/mK		
Larghezza telaio (Bf):	132.01 mm				Larghezza telaio (Bf):	110.00 mm		

Calcolo della trasmittanza termica U in conformità con UNI EN ISO 10077-2:2007

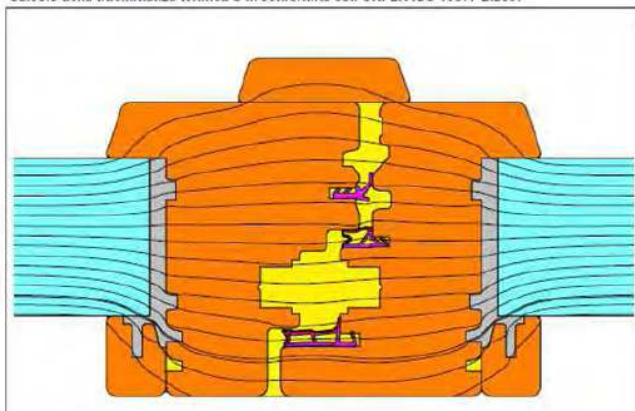

Calcolo della trasmittanza termica U in conformità con UNI EN ISO 10077-2:2007

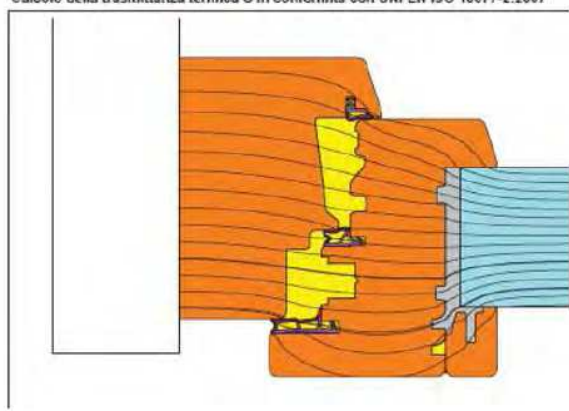

Consultar Disponibilidad.

PUERTAS



Las puertas **W-JART** están diseñadas con un perfil similar al de las ventanas que nos asegura una perfecta estanqueidad.

Se fabrica con una sección de 69 mm, apestañada, con doble junta de goma, bisagras regulables y en la parte inferior se puede solucionar con solera plana para salvar barreras arquitectónicas o burlete inferior oculto.

En cuanto a la seguridad, disponen de 5 puntos de cierre perimetrales y cerradura de seguridad en la fabricación estándar, a partir de ahí se puede reforzar la seguridad con blindajes, cerraduras automáticas, escudos anti vandálicos y bombines de alta seguridad.



Consultar Disponibilidad.

VENTANAS PARA TEJADO

SERIE 43

Pendientes admisibles de 15° a 85°



PIVOTANTE



BASCULANTE

Ventana fabricada en madera de pino nórdico de primera calidad, completamente barnizada en todas sus caras.

Serie 43 de PVC de color blanco reforzado con perfil metálico, ideal para instalar en cocinas, baños y zonas húmedas.

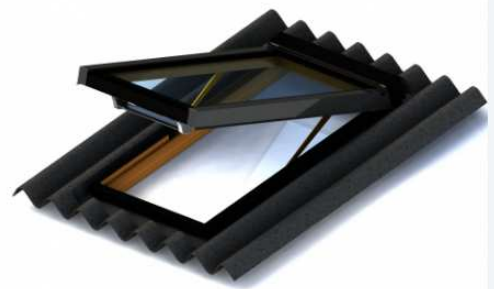
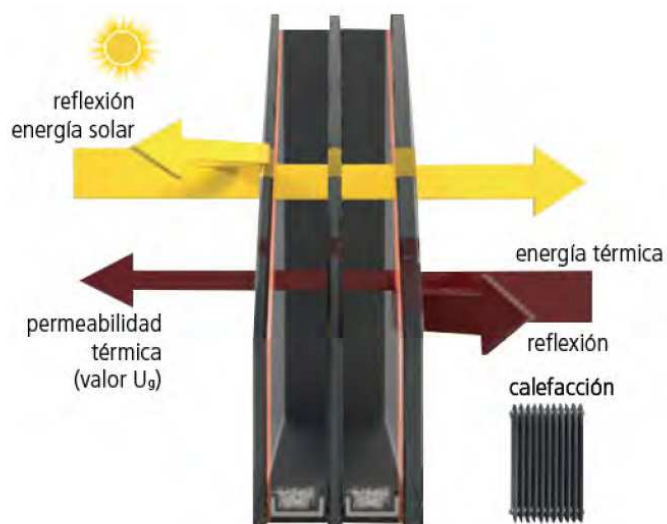

SERIE 73

PENDIENTES ADMISIBLES DE 15° A 65°



TOP PIVOTANTE/
PROYECTANTE

APERTURA MÁXIMA
38° BASCULANTE

Se caracteriza por su eje de rotación que proporciona la sensación de una apertura proyectante, se aconseja colocarla en medias y bajas alturas ya que ofrece amplia visibilidad exterior.



Consultar Disponibilidad.

Syncron[®] by ALNIC
structured panel LINE

22. COCINAS

PUERTAS DE COCINA



Anniversary Oak 01 RE *



Anniversary Oak 02 RE *



Anniversary Oak 03 RE *



Roble Muratti 01 MU

Consultar Disponibilidad.

Syncron[®] by ALNICO
structured panel LINE



Nogal Rosales 01 RE *



Nogal Rosales 02 RE *



Nogal Rosales 03 RE *



Roble Muratti 04 MU



Ice Cream 01 JA



Ice Cream 02 JA



Oxid 04 Grafitt SS



Goya 01 NA



Velázquez 01 AR



Velázquez 02 AR



Goya 02 NA

Consultar Disponibilidad.

Syncron[®] by ALNIC
structured panel LINE



Spatt 01 Blanco VE



Titan 01 PT



Factory 01 CRT



Factory 02 CRT



Noce 01 HO



Noce 03 HO



Como Ash 02 RE*



Lakeland Oak 03 SI



Picasso 01 AR



Picasso 02 AR



Picasso 03 AR



Woodline 03 BA

Consultar Disponibilidad.

Syncron[®] by ALNICO
structured panel LINE



Vulcano DY

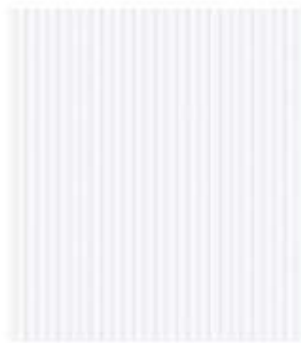

Blanco Polar DY



Vitamine DY

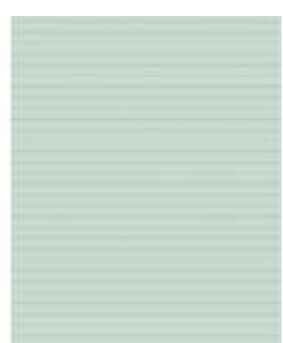

Vitamine AV



Trevi 02 AR **NEW**



Siena ST



Porcelain 01 Gold JA



Porcelain 03 Silver JA



Blanco JZ



Vitamine MI



Vulcano MI



Blanco Polar AV



Nogal Rosales **NEW**
04 * RE



Alhambra 01 NZ * **NEW**



Alhambra 02 NZ * **NEW**



Alhambra 03 NZ * **NEW**

Consultar Disponibilidad.

Zénit by ALVIC
High Resistance Surface



Magnolia SM



Cameo SM **NEW**



Arena SM



Cashmere SM



Basalto SM

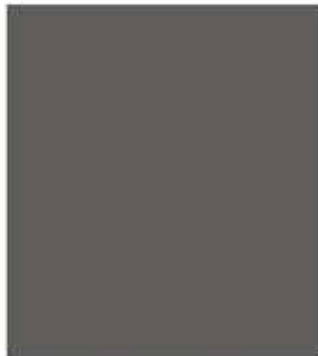

Gris Plomo SM



Antracita SM



Negro SM



Verde Salvia SM



Agua Marina SM



Azul Índigo SM



Azul Marino SM



Cotto SM



Almagra SM



Camel SM



Tortora SM

DISPONIBILIDAD DE CATALOGO
COMPLETO EN PDF



Diserfa / Design / Design :
Zéniñ Almogro SM



Cashmere MD



Gris Nube MD



Basalto MD



Antracita MD

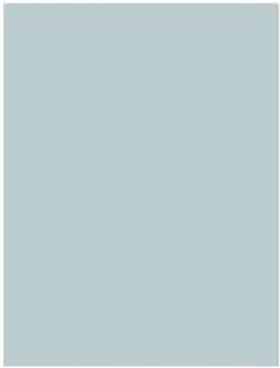

Ice Blue SM **NEW**



Azul Ultramar SM **NEW**

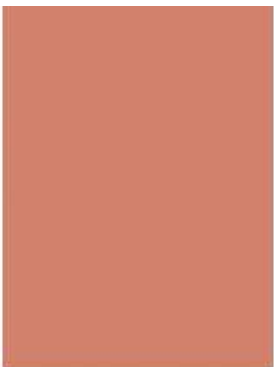

Coral SM **NEW**

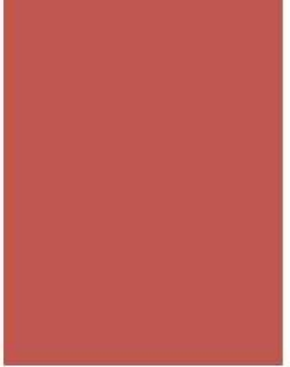

Rojo Pompei SM **NEW**

Consultar Disponibilidad.

Zénit by ALNICO
High Resistance Surface

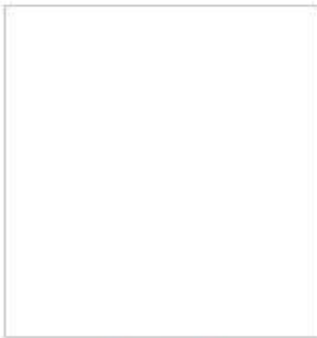

Blanco SM



Blanco Polar SM



Nuvola 01 SM



Nuvola 03 SM



Taupe SM **NEW**

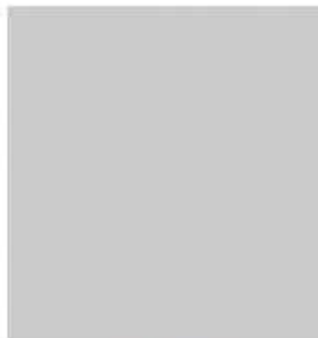

Gris Nube SM



Mármol Versilia SM

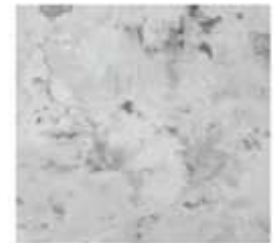

Osiris Plata SM



Ginger SM



Agave SM **NEW**



Steelboard Copper SM



Naranja Citrus SM **NEW**



Amarillo Albero SM **NEW**

Consultar Disponibilidad.

Luxe[®]
by ALNIC
STANDARD FINISH

LU
XE
PLUS
by ALNIC



Blanco

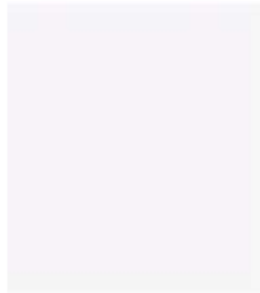

Blanco Polar *



Magnolia



Cashmere



Basalto

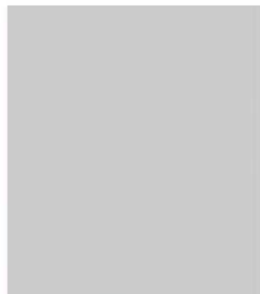

Gris Nube



Gris Plomo



Antracita



Agua Marina

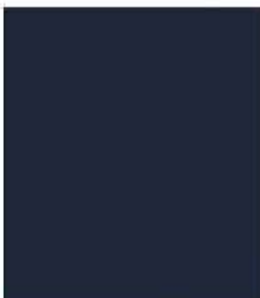

Azul Marino



Verde Salvia



Negro

Consultar Disponibilidad.

Luxe[®]
by ALNIC
PATENTED PRODUCT

LU
XE
PLUS
by ALNIC



Alto Brillo
High gloss
Haute brillante



Larga Durabilidad
Long Durability
Durabilité



Alta resistencia al rayado
Highly scratch-resistant
Haute résistance aux rayures



Azul Ultramar **NEW**

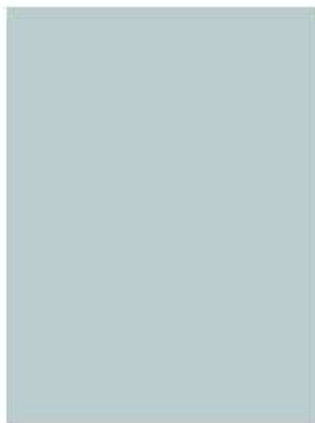

Ice Blue **NEW**



Rojo Pompei **NEW**

DISPONIBILIDAD DE CATALOGO
COMPLETO EN PDF

Consultar Disponibilidad.



QUADRO



Pieza 4 Cantos
Piece 4 Edges
Pièce 4 bords



FINGER- PULL



TIRADOR
INCORPORADO

Consultar Disponibilidad.

COLORES DISPONIBLES EN FINGER- PULL

Gama de acabados y colores disponibles

Range of finishes and colours available / Gamme de finitions et couleurs disponibles

Luxe



Zenit



Syncron



MattDeco



Activar Windows
Ve a Configuración para activar W

TIRADOR INTEGRADO

Mallorca

Tirador integrado sutil que recrea un efecto gola para muebles bajos.

Tirador

- Inox
- Plata Mate
- Negro Mate
- Blanco Mate



Zenit
Cashmere SM

Madeira

Tirador integrado con efecto cepillado que aporta un toque moderno.

Tirador

- Inox Cepillado
- Negro Cepillado



Zenit
Almagra SM

Menorca

Tirador integrado discreto, recomendado para muebles altos en complemento del Mallorca.

Tirador

- Inox
- Plata Mate
- Negro Mate
- Blanco Mate

Syncon
Picasso 01 AR



Ibiza

Tirador integrado con diseño y carácter que permite un agarre cómodo de la puerta.

Tirador

- Inox
- Plata Mate
- Cobre
- Negro Mate

Zenit
Verde Salvia SM



NEW

Formentera

Tirador integrado con diseño minimalista que se adapta a cualquier estilo.

Elige entre los 8 colores disponibles del tirador y combínalo con cualquier diseño de la gama JIT, consiguiendo acabados uniformes con la puerta a juego con el tirador, o con contraste para crear un proyecto moderno y único.

Los colores del tirador han sido especialmente diseñados con el mismo tono que la puerta.

Tirador

- Blanco
- Gris Nube
- Negro
- Azul Índigo
- Verde Salvia
- Agave
- Cashmere
- Cotto

*Sincron Alhambra 01
Tirador Azul Índigo*



Tenerife

Tirador integrados de diseño sofisticado con ángulo de 45 grados. Se combina con gola.

*Zenit
Azul Índigo SM*

Tirador

- Plata Mate



Lanzarote

Tirador integrado oculto para un acabado minimalista y elegante. Se combina con gola.

*Zenit
Nuvola 03 SM*

Tirador

- Inox
- Negro Mate



STOCK



MODULOS COCINA BLANCOS

MODELOS ALTOS, FONDO 33

MEDIDA	MEDIDA
	60*60 SC
70*30	90*30
70*35	90*35
70*40	90*40
70*45	90*45
70*50	90*50
70*60	90*60
70*70	90*70
70*80	90*80
70*90	90*90
70*100	90*100

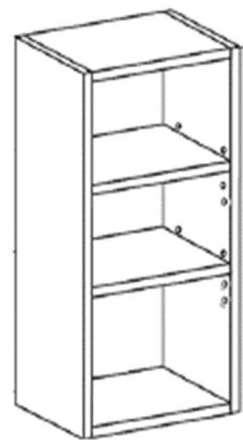
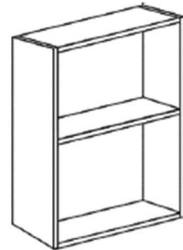

MEDIDA	
28*60	TRANSVERSAL
35*60	TRANSVERSAL
40*60	TRANSVERSAL
40*80	TRANSVERSAL

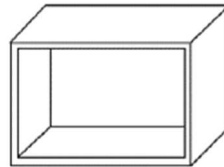

ESCURREPLATOS (HASTA FIN DE EXISTENCIAS)

MEDIDA	MEDIDA
70*50	90*45
70*60	90*50
70*70	90*70
70*80	90*80
70*90	

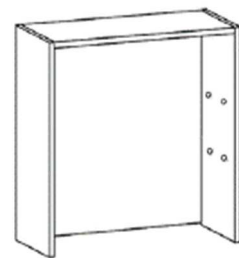

RINCON CHAFLÁN

MEDIDA
ALTO 70*63
ALTO 90*63

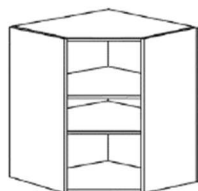

RINCÓN "L"

MEDIDA
ALTO 70*63
ALTO 90*63

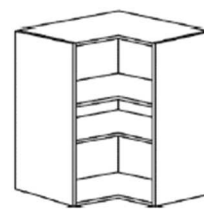

MÓDULOS COCINA BLANCOS

MODELOS BAJOS, FONDO 58	
MEDIDA	MEDIDA
70*30	80*30
70*35	80*35
70*40	80*40
70*45	80*45
70*50	80*50
70*60	80*60
70*70	80*70
70*80	80*80
70*90	80*90
70*100	80*100
	80*120

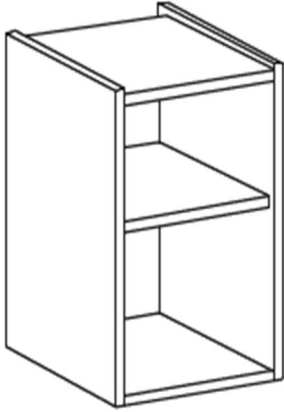

MODULO BAJO FREGADERO HIDRÓFUGOS	
MEDIDA	MEDIDA
70*45	80*45
70*50	80*50
70*60	80*60
70*70	80*70
70*80	80*80
70*90	80*90
70*100	80*100

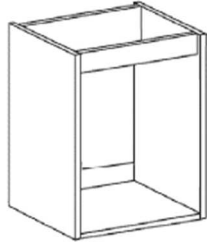

MODULO HORNO	
MEDIDA	MEDIDA
70*60	80*60

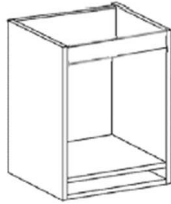

MODULO COLUMNA
MEDIDA
2200*40
2200*60

RINCÓN "L"
MEDIDA
BAJO 70*93
BAJO 80*93

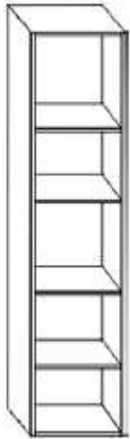
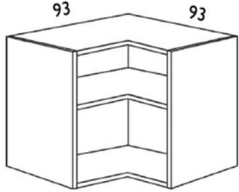

ENCIMERAS R3 SUPRA

Medidas: 3600*620*30mm (hasta final de existencias)



EP-002-SF / Blanco Soft



EP-050-MT / M3rml Micado

Medidas: 3600*620*38mm



EP-124-OP
Roble Sonoma Nat



EP-142-SN
Roble Ib3rico



P-092-IS
Cemento Oscuro



EP-141-NAT
Anniversary 02 Oak



EP-086-IS
Fresko 51301



EP-138-PI
Piedra Tripura



EP-090-PI
Piedra Carb3n



EP-151-ST / M3rml Marquina



EP-140-SM
M3rml Versilia

STOCK



Medidas: 3600*620*38mm

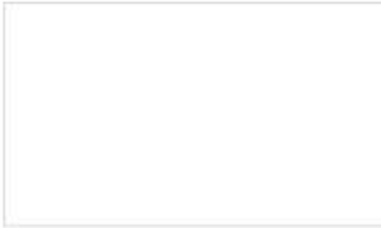

Blanco / EP-157-SM



Bernini / EP-163-LV



Nuvola 01 / EP-161-SM



Porcelain 01 Gold / EP-154-YO



Picasso 03 / EP-169-AR

ENCIMERAS COMPACTO LAMINADO

Medidas: 3660*1400*10mm

Fabricadas a partir de un laminado de alta presión sobre un núcleo compacto blanco o negro de 10 mm.

Compuestas por más de 100 capas de papel kraft prensado e impregnado con resinas termoendurecibles. Este proceso confiere al producto una estructura sólida, resistente a la humedad, al impacto y al desgaste,



Consultar Disponibilidad.



NUVOLA 01 SM

Núcleo blanco



NUVOLA 02 SM

Núcleo blanco



NUVOLA 03 SM

Núcleo blanco

Consultar Disponibilidad.



ARDOISE ST01

Núcleo negro









PICASSO 03

Núcleo negro



VELAZQUEZ 02

Núcleo negro

	Resistencia al vapor de agua	Clase 5	EN 438-2
	Resistencia al calor seco (160 °C)	Clase 5	EN 438-2
	Resistencia al calor húmedo (100 °C)	Clase 5	EN 438-2
	Resistencia al rayado	≥ 4N	EN 438-2
	Resistencia al manchado	Clase 5	EN 438-2
	Resistencia del color a la luz	≥ 4 (escala gris)	EN 438-2
	Actividad antibacteriana tras 24 horas	≥ 99,9%	JIS Z 2801

STOCK

Finsa

ENCIMERAS FINTOP XTRIM

MEDIDAS: 3600*630*13mm



SOPORTE Compac Plus EZ 3600x630x13 mm - 29 kg/ud

CANTO FRONTAL Postformado doble: Radio 5 mm

OBSERVACIONES La diversidad de colores y posibilidades permiten que este producto se utilice también para otras aplicaciones como: mesas de trabajo, mobiliario de hostelería, etc.

Disponibilidad de:

- Lámina para canto de cada diseño para remates.
- Perfiles de aluminio para unión en recto y esquina.
- Tablero para panelar 3600x1400x13mm
- Copete/Zócalo en 3600x150x13mm

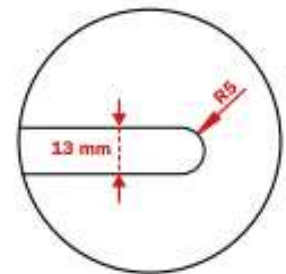

1AT **MARMOL HADES**



6AS **ROBLE AMAZONA**



72Y **MARMOL BLANCO**

Consultar Disponibilidad.



MOSTRADORES

MEDIDAS

MOSTRADOR ALVIC 3600*700*38 mm

MOSTRADOR ALVIC 3600*800*38 mm

MOSTRADOR ALVIC 3600*900*38 mm



STOCK

COMPLEMENTOS COCINA

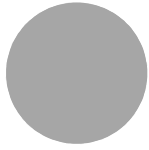

Aluminio

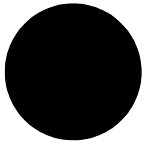

Negro mate

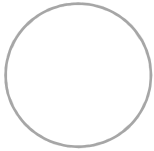

Blanco mate

COPETE CLÁSICO

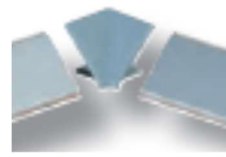

COPETE D7



TERMINACION ENCIMERA



T- EMPALME

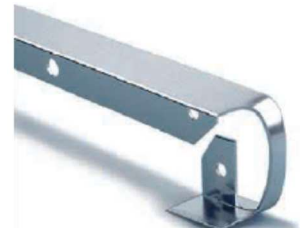

T- POSTFORMADA

En PLATA. BLANCO Y NEGRO

COPETE DECORATIVO



Tira laminada copete: 3600x140

PANEL MURAL ENCIMERA



EN STOCK:

- ANV OAK 02
- BERNINI
- FRESKO OSCURO
- P. CARBON
- P. TRIPURA
- PORCELAIN GOLD
- R. SONOMA

Medidas: 3000 x 630 x 09mm

Posibilidad de conseguir otros modelos bajo pedido

STOCK



TIRADORES

TIRADOR ASA U CROMO MATE



TIRADOR ASA U NEGRO MATE



TIRADOR ASA N°107 CROMO MATE



TIRADOR ASA N°107 NEGRO MATE



TIRADOR ASA N°1216 CROMO MATE



TIRADOR ASA N°2510 NEGRO MATE



TIRADOR ASA N°1216 NEGRO MATE



POMO N°2510
NEGRO MATE



TIRADOR ASA N°1219 NEGRO MATE



STOCK

emuca 
furniture fittings solutions



TIRADOR CAIRO PL VIEJA



TIRADOR PAPUA



POMO DUKE

Viefe10 ANNI
VERSI
ALTY



TIRADOR DINO



TIRADOR SENSE NEGRO



STOCK



TIRADOR SENSE INOX

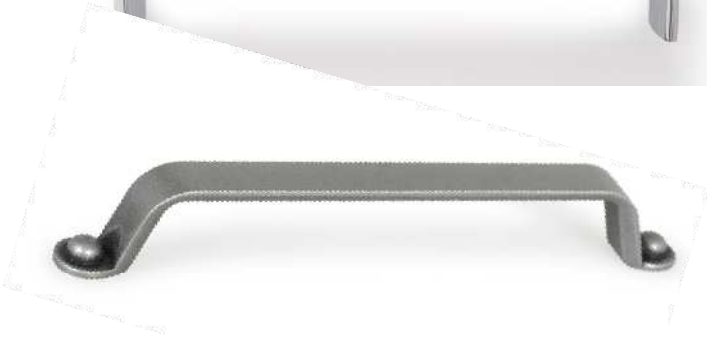

TIRADOR BUTTON



TIRADOR ESTE



TIRADOR BAU

STOCK



CAJÓN COCINA ADVANCED

ADVANCED H87 ADVANCED H117

ADVANCED H183

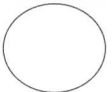

Embalaje individual

-  ANTRACITA
-  BLANCO



Set Barra Gaveta Alt. Libre Antracita



Set Barra Gaveta Alt. Libre Blanco

FONDO 500mm

Para otros fondos consultar disponibilidad

STOCK

BISAGRAS MÓDULOS

BISAGRA RECTA CON FRENO + BASE

Grosor de la puerta de 14 a 23 mm.

Regulación de la puerta horizontal de 0-5mm y profundidad de 0-4mm.

Cierre diferenciado de muelle. Sistema automático de montaje de la bisagra al suplemento.



COMPLEMENTOS PARA MÓDULOS

PATAS

PATAS 13-19 NEGRA
PATAS 9-13 NEGRAS



ABRAZADERAS

PARA ZOCALO PVC
PARA ZÓCALO DE MADERA



MARCO MICROONDAS

STOCK

PROTECTOR PVC ZÓCALO GOMA

ZÓCALO PVC LAMINADO ALUMINIO CEPILLADO / BLANCO / NEGRO

ÁNGULO VARIABLE PERNIO ALUMINIO / BLANCO / NEGRO



COMPLEMENTOS COCINA

REJILLA HORNO

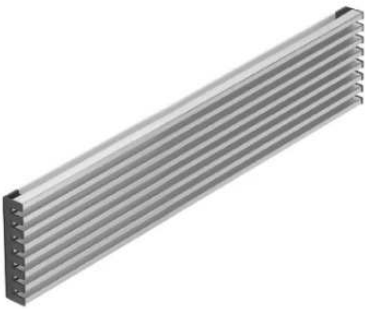

CUBERTERO MADERA VERSATILE ADAPTABLE



NUEVO

CUBERTERO BLANCO / ANTRACITA

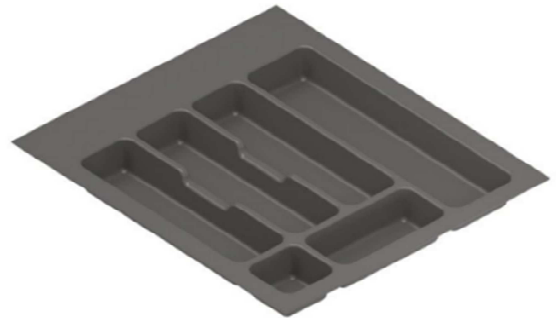

STOCK

AGT

23. SUELO

AC-5
ultra
plus serie

AC-5
ultra
line serie bisel



AGT ULTRA PLUS NATURAL OAK

SUELO LAMINADO AGT ULTRA PLUS AC-5 Y AGT ULTRA LINE AC-5

PAVIMENTO LAMINADO AGT ULTRA PLUS AC-5 Y AGT ULTRA LINE AC-5



Clase 33 |
Classe 33



Garantía doméstica: 30 años |
Garantia doméstica: 30 anos



Fáciles y rápidos de instalar. |
Fáceis e rápidos de instalar.



Resistencia al desgaste: AC5 |
Resistência ao desgaste: AC5



Garantía comercial: 12 años |
Garantia comercial: 12 anos



Higiénicos (evitan alergias y
ácaros). | Higiénicos (evitam
alergias e ácaros).



Resistencia al golpeo: IC3 |
Resistência às marcas: IC3



Antiestático |
Antiestático



Aportan decoración. |
Trazem decoração



Hinchazón: < 12 % |
Inchamento: < 12 %



Proteccion borde contra agua |
Proteção dos bordos contra água



Económicos. |
Económicos.



Fáciles de mantener y limpiar. |
Fáceis de manter e limpar.



AGT ULTRA LINE :
Con Bisel |
Com Bisel.

AC-5
ultra
plus serie

AC-5
ultra
line serie bisel



TIBET
TIBET C/ BISEL
1200 x 191 x 8 mm



ALTAY
ALTAY C/ BISEL
1200 x 191 x 8 mm

TERMINACIÓN
Textura

TERMINAÇÃO
Texturizado



NATURAL OAK
NATURAL OAK C/ BISEL
1200 x 191 x 8 mm



OLIMPUS
OLIMPUS C/ BISEL
1200 x 191 x 8 mm



NIL
NIL C/ BISEL
1200 x 191 x 8 mm



MERIC
MERIC C/ BISEL
1200 x 191 x 8 mm



TUNA
TUNA C/ BISEL
1200 x 191 x 8 mm



SELGE
SELGE C/ BISEL
1200 x 191 x 8 mm



SUELO LAMINADO AGT NATURA AC-4 | PAVIMENTO LAMINADO AGT NATURA AC-4:



Clase 32 |
Classe 32



Resistencia al desgaste: AC4 |
Resistência ao desgaste: AC4



Resistencia al golpeo: IC2 |
Resistência às marcas: IC2



Hinchazón: < 16 % |
Inchamento: < 16 %



Fáciles de mantener y limpiar. |
Fáceis de manter e limpar.



Garantía doméstico: 25 años |
Garantia doméstica: 25 anos



Garantía comercial: 10 años |
Garantia comercial: 10 anos



Antiestático |
Antiestático



Proteccion borde contra agua |
Proteção dos bordos contra água



Fáciles y rápidos de instalar. |
Fáceis e rápidos de instalar.



Higiénicos (evitan alergias y ácaros). |
Higiénicos (evitam alergias e ácaros).



Aportan decoración. |
Trazem decoração.



Económicos. |
Económicos.



STOCK



API2 - TALYA
1200 x 191 x 8 mm



SELGE



OLIMPUS



AP- LUGANO



AP- PORTOFINO



CON BISEL



**NIL
NIL C/ BISEL**
1200 x 191 x 8 mm



TREND C/ BISEL



CANYON C/ BISEL



VOLGA C/ BISEL



GALA MESE C/ BISEL

AC-4

effect

Bisel poro sincronizado

EFFECT PREMIUM AC-5

BISEL PORO SINCRONIZADO 12 MM



AGT EFFECT PAMIR

SUELO LAMINADO AGT EFFECT AC-4 Y EFFECT PREMIUM AC-5 | PAVIMENTO LAMINADO AGT EFFECT AC-4 Y EFFECT PREMIUM AC-5:



Garantía doméstico: 30 años |
Garantía doméstica: 30 anos



Fáciles de mantener y limpiar. |
Fáceis de manter e limpar.



Con Bisel |
Com Bisel.



Aportan decoración. |
Trazem decoração.



Garantía comercial: 12 años |
Garantía comercial: 12 anos



Antiestático |
Antiestático



Fáciles y rápidos de instalar. |
Fáceis e rápidos de instalar.



Visual Sincronizado |
Visual Sincronizado



Hinchazón: < 12 % |
Inchamento: < 12 %



Proteccion borde contra agua |
Proteção dos bordos contra água



Higiénicos (evitan alergias y
ácaros). | Higiénicos (evitam
alergias e ácaros).

SUELO LAMINADO AGT EFFECT AC-4 | PAVIMENTO LAMINADO AGT EFFECT AC-4:



Clase 32 |
Classe 32



Resistencia al desgaste: AC4 |
Resistência ao desgaste: AC4



Resistencia al golpeo: IC2 |
Resistência às marcas: IC2

SUELO LAMINADO AGT EFFECT PREMIUM AC-5 | PAVIMENTO LAMINADO AGT EFFECT PREMIUM AC-5:



Clase 33 |
Classe 33



Resistencia al desgaste: AC5 |
Resistência ao desgaste: AC5



Resistencia al golpeo: IC3 |
Resistência às marcas: IC3

STOCK



EFFECT PREMIUM AC-5
BISEL
PORO SINCRONIZADO
12 MM



ALP
1200 x 191 x 8 mm
1200 x 191 x 12 mm



PAMIR
1200 x 191 x 8 mm
1200 x 191 x 12 mm

TERMINACIÓN
Textura Sincro

TERMINAÇÃO
Texturizado Sincronizado



URAL
1200 x 191 x 8 mm
1200 x 191 x 12 mm



FUJI
1200 x 191 x 8 mm
1200 x 191 x 12 mm



TIBET
1200 x 191 x 8 mm
1200 x 191 x 12 mm



ALTAY
1200 x 191 x 8 mm
1200 x 191 x 12 mm



EVEREST
1200 x 191 x 8 mm
1200 x 191 x 12 mm



TOROS
1200 x 191 x 8 mm
1200 x 191 x 12 mm

YILDIZ				
Medidas	1805 x 243 x 8 mm	Biselado	m² / Caja	2,193
			m²/palets	131,58
Capa uso		Sistema de Anclaje	N° cajas/palets	

PSTYXLAGPE697	Agva
PSTYXLCPE695	Cide
PSTYXKPE694	Kerpe
PSTYXLCPE846	Cebeci
PSTYXLAPE696	Amasra

Agva

Cide

Kerpe

Cebeci

Amasra

Finfloor



catálogo



Finfloor

STOCK

dura
ble

COLECCIÓN **EVOLVE**
| suelos

Núcleo



HDF Bajo
Hinchamiento
(< 8%)



Baja emisión de
formaldehído

Durabilidad



Resistencia a la
abrasión



Comercial intenso
Doméstico intenso
(EN ISO 13329)



Apto para
baños y cocinas

Garantías



Seguridad



Antiestático
(EN 14041/EN 1815)



Reacción al fuego Bfl-S1
(EN 14041/EN 13501)

Instalación



Instalaciones de 12 x 12 m
144 m² sin perfiles



Sistema Clic
Tecnología protegida
(EP 0 843 763 - US 6 006 486)



Sellado de cantos



Formato de lama

Evolve 1331 x 194 mm





ROBLE

ARLES NATURAL

FINFLOOR - EVOLVE



ROBLE

WEXFORD TOSTADO

FINFLOOR - EVOLVE



ROBLE

KALMAR ESENCIA

FINFLOOR - EVOLVE

Finfloor





**ROBLE
KALMAR GRIS**
FINFLOOR - EVOLVE



**ROBLE
VIENA DORADO**
FINFLOOR - EVOLVE



**ROBLE
FADO BRISA**
FINFLOOR - EVOLVE



Finfloor

STOCK

dura
ble

COLECCIÓN **SUPREME** | suelos

Núcleo



HDF Bajo
Hinchamiento
(< 8%)



Baja emisión de
formaldehído

Durabilidad



Resistencia a la
abrasión



Comercial intenso
Doméstico intenso
(EN ISO 13329)



Apto para
baños y cocinas

Garantías



Seguridad



Antiestático
(EN 14041/EN 1815)



Reacción al fuego Bfl-S1
(EN 14041/EN 13501)

Instalación



Instalaciones de 12 x 12 m
144 m² sin perfiles



Sistema Clic
Tecnología protegida
(EP 0 843 763 - US 6 006 486)



Sellado de cantos



Formato de lama

Supreme 1310 x 240 mm





**ROBLE
GAIA DOLOMITES**
FINFLOOR - SUPREME



**ROBLE
GAIA DALMATATA**
FINFLOOR - SUPREME



**ROBLE
GAIA LORETO**
FINFLOOR - SUPREME



ROBLE GAIA VICTORIA

FINFLOOR - SUPREME

Finfloor



FRESNO TANGO ETNA

FINFLOOR - SUPREME



ROBLE
SELENA TOSTADO
FINFLOOR - SUPREME



ROBLE
SELENA DORADO
FINFLOOR - SUPREME

STOCK

Finfloor

COLECCIÓN **ORIGINAL** suelos

Núcleo



Hydroprotect
HDF alta estabilidad dimensional



Baja emisión de formaldehído

Durabilidad



Resistencia a la abrasión



Comercial intenso
Doméstico intenso
(EN ISO 13329)



Apto para baños y cocinas

Garantías



Seguridad



Antiestático
(EN 14041/EN 1815)



Reacción al fuego Bfl-S1
(EN 14041/EN 13501)

Instalación



Instalaciones de 9 x 9 m
81 m² sin perfiles



Sistema Clic
Tecnología protegida
(EP 0 843 763 - US 6 006 486)



Sellado de cantos



Sin hiel

Formato de lama

Original 1331 x 194 mm





ROBLE CHIC

FINFLOOR - ORIGINAL



ROBLE COLUMBIA

FINFLOOR - ORIGINAL



ROBLE GLAMOUR

FINFLOOR - ORIGINAL

Finfloor

RACASO
MADERAS



ROBLE RETRO

FINFLOOR - ORIGINAL



ROBLE TAUPE

FINFLOOR - ORIGINAL



ROBLE OBELISQUE

FINFLOOR - ORIGINAL

Finfloor

RACASO
MATERIAS



ROBLE CALCIC

FINFLOOR - ORIGINAL



ROBLE PARAMOUNT

FINFLOOR - ORIGINAL



ROBLE VINTAGE

FINFLOOR - ORIGINAL



ROBLE TITANIO

FINFLOOR - ORIGINAL



ROBLE SERRADO

FINFLOOR - ORIGINAL



ROBLE OTOÑO

FINFLOOR - ORIGINAL

Finfloor





ROBLE EGEO

FINFLOOR - ORIGINAL



ROBLE BROMO

FINFLOOR - ORIGINAL

Finfloor





ROBLE JASPER

FINFLOOR - ORIGINAL



ROBLE OLIMPO

FINFLOOR - ORIGINAL

Finfloor

RACASO
MADRID

Finfloor



PUREFLOOR 7

| suelos



Resistencia a la abrasión
Abrasion-resistant
Resistência à abrasão



Doméstico intensivo
Comercial moderado
High domestic
Moderate commercial
Doméstico intensivo
Comercial moderado
(EN ISO 10874)



Reacción al fuego C_s-s1
Reaction to fire C_s-s1
Reação ao fogo C_s-s1
(EN 14041/EN 13501)



Sellado de cantos
Sealed edges
Selado de cantos



Sin bisel



Garantía
Warranty
Garantia



Fácil instalación
Easy installation
Instalação fácil

Formato - Format - Formato



7 mm
Espesor
Espessura
Epessura

2,582 m²
Caja
Pack
Caixa

x10 uds
Packs
Packs
Peças



STOCK



ROBLE 3.3
PUREFLOOR



HAYA 3.1
PUREFLOOR



ROBLE SIROCO
PUREFLOOR

Finfloor



COMPLEMENTOS

FINFLOOR EN BAÑOS Y COCINAS



Silicona de aplicación perimetral



Sellador de juntas

PERFILES DE ALUMINIO

Perfil de expansión



Perfil de transición



Perfil terminal



RODAPIÉS

Rodapiés de color a juego



Clip instalación rodapiés



Junquillo de color a juego



MAMPERLÁN



NEW

STOCK

1200

SILMARFLOORING

DIMENSIONES: 1220*180*5.7mm

N.º PIEZAS: 10pcs/ 2.160m2/ box

GUADIANA



GUADALQUIVIR



DUERO



MIÑO



EBRO



GENIL



NEW

STOCK

1500

SILMARFLOORING



DIMENSIONES: 1520*230*6mm

N.º PIEZAS: 6pcs/ 2.10m2/ box

MAINE



SENA

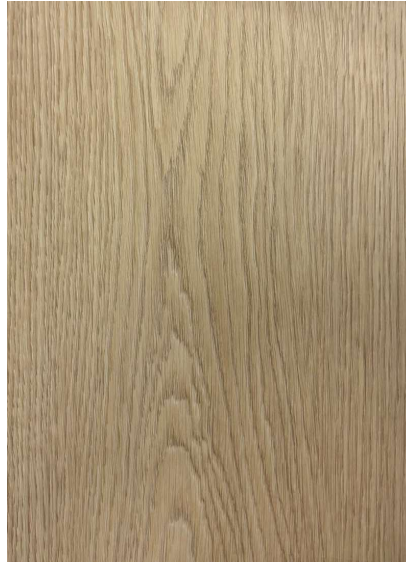

MARNE



RODANO



DORDOÑA



GARONA



ESPECIFICACIONES

SILMARFLOORING



Minimiza el uso de juntas de dilatación
/ Minimizes the use of expansion joints
/ Minimise l'utilisation des joints
de dilatation / Minimiza o uso de juntas
de dilatação



Resistente a los golpes / Shock
resistant / Résistant aux chocs
/ Resistente aos golpes



A prueba de agua / Waterproof
/ Étanche / À prova de água



No desprende olor / Odourless / Ne
libère pas d'oeur / Não liberta cheiro



Apto para calefacción radiante
/ Suitable for underfloor heating
/ Convient pour chauffage au sol
/ Apto para piso radiante



Aportan decoración / Add design
value / Décore / Trazem decoração



Comodidad para caminar / Comfort
when walking / Confort de marche /
Conforto ao caminhar



Suelo apto para niños / Child friendly
Flooring / Sol adapté aux enfants
/ Pavimento adequado para crianças



Tolera imperfecciones del subpavimento
/ Absorbs imperfections of underfloor
/ Tolère les imperfections de la
sous-couche / Tolera imperfeições
do subpavimento



Antiestático / Anti-static
/ Antistatique / Antiestático



Aislamiento acústico / Acoustic
Insulation / Insonorisé / Isolamento
acústico



Estructura rígida / Rigid Core
/ Structure rigide / Estrutura Rígida



Undercover incorporado / Built in
Undercover / Sous couche intégrée
/ Undercover incorporado



Económicos / Affordable /
Economiques / Económicos



Garantía residencial - 20 años /
Residential warranty - 20 years /
Garantie résidentielle - 20 ans /
Garantía residencial - 20 años



Son fáciles y rápidos de instalar
/ Easy and fast to install / Sont
faciles et rapides à installer
/ São fáceis e rápidos de instalar



Garantía comercial - 10 años / Comer-
cialwarranty - 10 years / Garantiecom-
mercial - 10 ans / Garantía comercial -
10 años



Son fáciles de mantener y limpiar
/ Easy to maintain and clean
/ Faciles à entretenir et à nettoyer
/ São fáceis de manter e limpar

SUELO VINÍLICO PREMIERCLICK +

1220*225*5.7mm

+
**PLUS
COVER**
SOLUTIONS



STOCK



Ordesa



Torreon



Picos



Gredos



Mulhacen



Nevosa



Puig



Borosa



Almanzor



Aneto

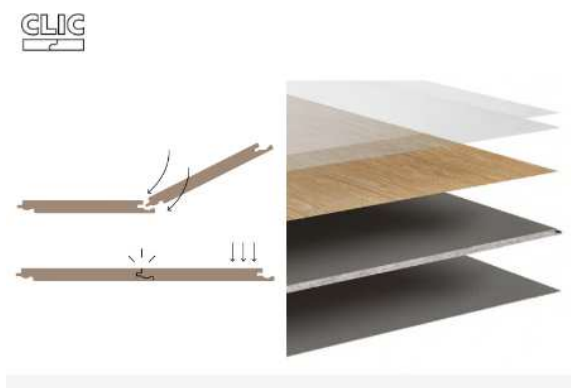

+
**PLUS
COVER**
SOLUTIONS



PREMIERCLICK +

STOCK

1220*225*5.7mm



Alcazaba



Moncayo



Peñalara



Maladeta



Veleta

NEW

PREMIERCLICK CERAMIC +

600*300*5.7mm

+

VYCOVER
BY PLUS COVER

STOCK



Cement Grey



Cement Black



Metal



Tatun

NEW

ARTECH HD

1520*228*6.5mm

STOCK

+

VYCOVER
BY PLUS COVER



HERMITAGE



TATE



SERRALVES



NATIONAL



PRADO



SOFIA



METROPOLITAN



LOUVRE

CLIC



NEW

STOCK

+

VYCOVER
BY PLUS COVER

QUATERRA

1520*230*6mm



Staten



Queens



Brooklyn



Harlem



Madison



Belmont



Hudson



Aislamiento acústico



Undercover
incorporado



Antiestático



Apto para calefacción
radiante



A prueba de agua



Instalación rápida y
fácil



Aportan decoración



Son higiénicos

ABSOLUT COMFORT

1810*229*8mm

Consultar Disponibilidad.



Organza

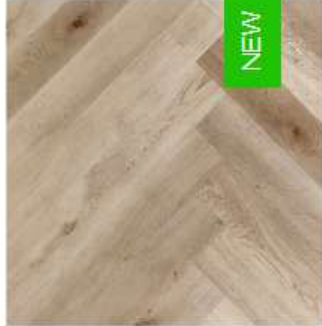

Organza Herringbone



Aspen



Azure Herringbone



Shale



Azure



Teal



Dune

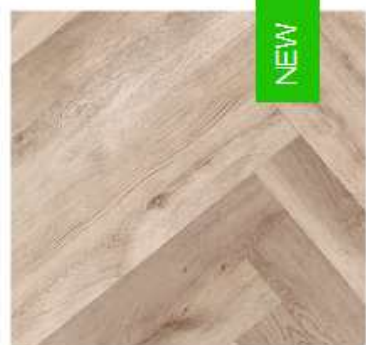

Teal Herringbone



HT RETAIL MAGNUM

2200*230*7mm

[Consultar Disponibilidad.](#)



Fiorland



Otway



Tongass



Valdivian



Daintree



Nisene



Mawson



Kinabalu

Consultar Disponibilidad.

+

VYCOVER
BY PLUS COVER

CLASSIC HERRINGBONE

875*125*8mm



Organza
875 x 125 x 8 mm



Azure
875 x 125 x 8 mm



Teal
875 x 125 x 8 mm

CLASSIC CHEVRON

600*127*7mm



Paddington



Chelsea



Oxford

CLASSIC MOSAICO



Cheverny



Chambord



Ambois

TARIMA TECNOLÓGICA

“TRADICIONAL TEXTURE”

Consultar Disponibilidad.



Certificado C3 anti deslizamento – Apto para edificios públicos, restaurantes, hoteles, terrazas y para piscinas.



Resistentes al agua

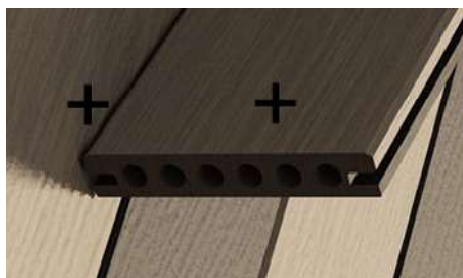

Alta resistencia a los agentes atmosféricos y a la radiación UV.



Garantía estructural de 25 años para áreas domésticas.
Garantía de desgaste de 15 años para áreas comerciales.

Consultar Disponibilidad.

+
DECKCOVER
BY PLUS COVER

“ENCAPSULADO DUO”



Borneo

2200*140*22.5mm



Sumba

2200*150*23mm



Boracay

2200*150*23mm



Sumatra

2200*140*22.5mm

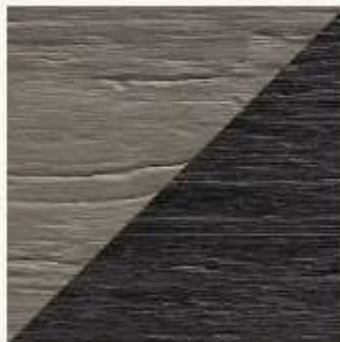

Kuta

2200*150*23mm



Samui

2200*150*23mm



Sistema De Clic



Alineacion Perfecta De
La Placa



Fácil de limpiar y
mantener



Aportan decoración



Resistente a agentes
atmosféricos



Instalacion Rapida Y
Facil

Consultar Disponibilidad.

+
BAMCOVER
BY PLUS COVER

OUTDOOR

Gama: Bamcover outdoor

Tipo de suelo: Tarima de Bambú

Visual: Bambú

Acabado: ACEITE

Dimensiones: 1860 x 140 x 20 mm
1850 x 139 x 18 mm

Aplicación: GRAPA/RASTREL



KRABI

1860 x 140 x 20 mm

KRABI 18

1850*139*18mm



PHUKET

1860 x 140 x 20 mm



PHUKET



KRABI



Alta estabilidad
Mucho más estable que la mayor parte de maderas tropicales - con las cabezas de lama machihembradas para una fácil instalación (imposible con otras maderas).

INDOOR

Gama: Bamcover indoor

Tipo de suelo: Tarima de Bambú

Visual: Bambú

Acabado: Barniz satinado ecológico

Dimensiones: 960 x 96 x 15 mm

Aplicación: Flotante T&G



SHANGAI

960*96*15mm

Consultar Disponibilidad.

T&G

+
BAMCOVER
BY PLUS COVER



1. Barniz Ecológico UV acrílico
2. Pieza maciza de bambú compuesta de tiras de bambú pegadas verticalmente

INDOOR

Gama: Bamcover indoor

Tipo de suelo: Tarima de Bambú

Visual: Bambú

Acabado: Barniz mate ecológico

Dimensiones: 1850 x 142 x 14/4 mm

Aplicación: Flotante T&G



GUILIN

1850x142x14/4mm



HARBIN

1850x142x14/4mm

T&G



1. Barniz Ecológico UV acrílico Mate
2. Pieza maciza de bambú compuesta de fibras encoladas y prensadas a alta resistencia y temperatura
3. Contrachapado fenólico de alta densidad con gran estabilidad

Consultar Disponibilidad.

+
BAMCOVER
BY PLUS COVER

INDOOR

Gama: Bamcover indoor

Tipo de suelo: Tarima de Bambú

Visual: Bambú

Acabado: Barniz mate ecológico

Dimensiones: 915 x 130 x 10/2,5 mm

Aplicación: Flotante CLIC



SANYA

920x125/130x10/2.5mm



XIAN

920x125/130x10/2.5mm

CLIC

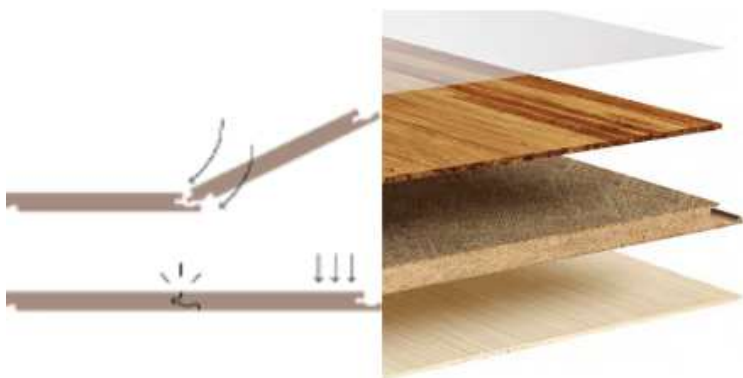

1. Barniz Ecológico UV acrílico Mate
2. Pieza maciza de bambú compuesta de fibras encoladas y prensadas a alta resistencia y temperatura
3. Fibra de alta densidad
4. Madera de Álamo

Consultar Disponibilidad.

+
WOODCOVER
BY PLUS COVER

OAK GRAN NATURA

SIN BARNIZAR



Quebec

Texas

1900/2200x190x20/6mm

2200x260x20/6mm

BARNIZ MATE



Laval

Toronto

1900/2200x190x20/6mm

2200x220/240x20/6mm

El suelo sin terminar – crudo
requiere sella con aceite o barniz
para suelos de madera

Roble europeo con nudos
característicos de esta madera



Montreal

Vancouver

2200x300x20/6mm

2200x260x20/6mm

El suelo sin terminar -
crudo, requiere sellar con
aceite o barniz para suelos
de madera
Roble europeo con nudos
característicos de esta
madera natural



Garantía
Residencial - 25 años



Higiénicos
(evitan alergias y ácaros).



Producto natural.



Tabla extra larga y extra
ancha.



Fácil de mantener
y limpiar.



Apto para calefacción
radiante.



Comodidad para caminar



Aportan decoración.

Consultar Disponibilidad.

+
WOODCOVER
BY PLUS COVER

OAK NATURA

BARNIZ MATE



Bruselas

1860/1900x190x14/3mm



Bilbo

2200x260x15/4mm



Donosti

2200x260x15/4mm



Zaragoza

1860/1900x190x14/3mm



Toledo

1860/1900x190x14/3mm



Crudo

1860/1900x190x14/3mm



Córdoba

1860/1900x150x14/3mm



Gasteiz

2200x260x15/4mm

SATINADO



Sevilla

1860/1900x150x14/3mm

Consultar Disponibilidad.

+
WOODCOVER
BY PLUS COVER

OAK NATURA PREMIUM



Paris

1900x190x14/3mm



Singapur

1900x190x14/3mm

1. Barniz Ecológico UV acrílico o crudo
2. Capa noble de roble europeo
3. Núcleo de contrachapado fenólico de alta densidad y dureza



Gijon

1900x190x14/3mm



Salamanca

1900x190x14/3mm

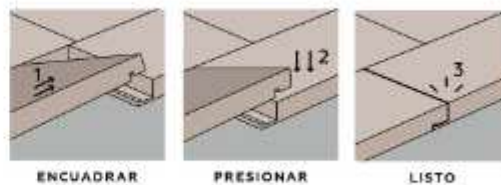
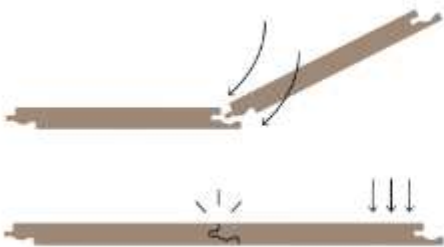

NEW

+

PLUS
COVER
SOLUTIONS

ecover

ECOVER

STOCK

2600x11200x8mm



Macael pw01/ gloss



Bernini pw02/ matt



Ankara pw03 / matt/ gloss



Asuan pb01/ matt



Mares pb02/ matt



Makrana pm01/ matt



Olapse pm02/ gloss



Portoro pg01/ matt



Markina pd01/ gloss

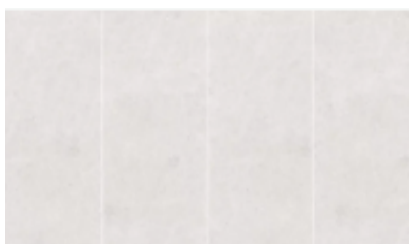

Pearl ng01/ concrete/ matt



Geo ng02/ concrete/ matt



Limestone nb01/ concrete/ matt

STOCK

ecover

ECOVER

2600x11200x8mm



Oak bw01/ matt

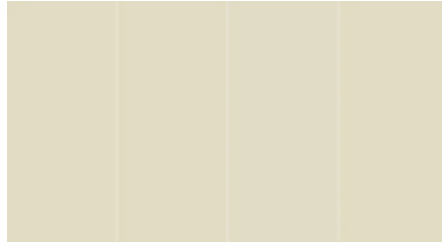

Vainilla sc01/ matt

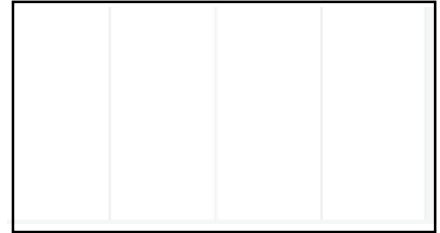

Cotton sw01/ matt



Galaxy sc02/ matt

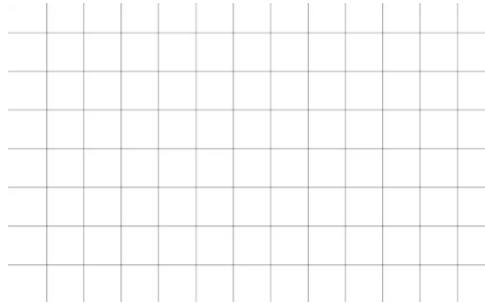

Grid tw01/ tiles

Ventajas



Estabilidad dimensional



Libre de PVC y asbestos



Grandes superficies sin repetición



Resistencia al rayado



Resistencia al teñido



A prueba de agua



Son higiénicos



Resistencia Al Fuego



Aportan decoración



Fácil de limpiar y mantener



Instalación rápida y sencilla



Union T&G



Tamaño XXL



Tacto suave

Material ecológico y versátil para revestir paredes ahorrando tiempo de instalación y mano de obra

NEW

STOCK

+

VYCOVER
BY PLUS COVER

VYWALL

2600x900x5mm

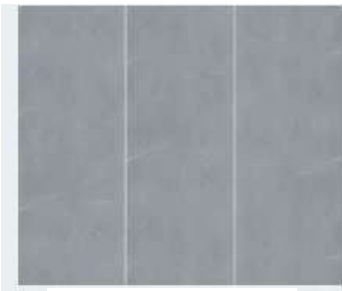

DELOS



NERA

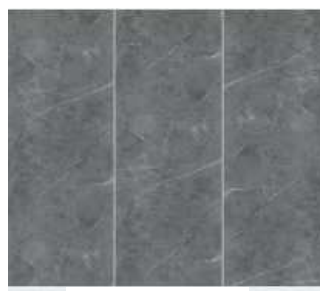

POMPEII

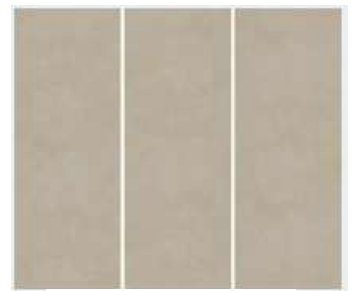

TALASA

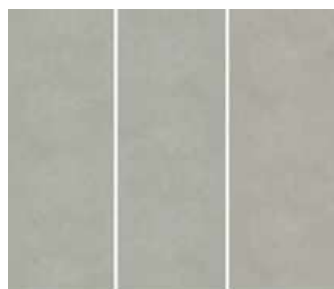

TARIFA



VENETIA



VESTA



PETRA



CIRO



ELEA

Ventajas



Tamaño XXL



Resistencia al teñido



Son higiénicos



Resistencia al rayado



Aportan decoración



Instalación rápida y fácil



Fácil de limpiar y mantener



Tacto suave

NEW

skincover

SKINCOVER



Seia
2700x1200x(1-4,5)mm



Silex
1200x600x(1-4,5)mm



Tivoli
1200x600x3 mm



Terran
2400x1200x3mm



Alaro
1200x600x3,2 mm



Khan
2700x1200x(1-3)mm



Fuste
1400x600x(1-5)mm



Chesnay
1200x600x2,6-5 mm



Terke
2700x1200x3mm

Material de revestimiento de piedra molida que ofrece versatilidad, durabilidad y estética



Kenzo
2800x1200x2,5 mm

STOCK

ROBLE CELLA

PARQUET ROBLE RÚSTICO CELLA 3 LAMAS CLIC 2200*205*14/3 (3,61 m²)



IPE

STOCK



DECK IPE GRAPA OCULTA

95*2mm

DECKING IPE BRASIL GRPA OCULTA

140*21mm

90*21mm

FINGER MULTIJJOIN DE LAPACHO GRAPA OCULTA

130*21mm

140*21mm

145*21mm

80*15mm

95*15mm



DECK SUCUPIRA GRAPA OCULTA

120*20mm

DECK IPE GRAPA VISTA

100*20mm

95*20mm

95*21mm

FINGER MULTIJJOINT IPE GRAPA VISTA

11.5*21mm

90*21mm

100*21mm

120*21mm

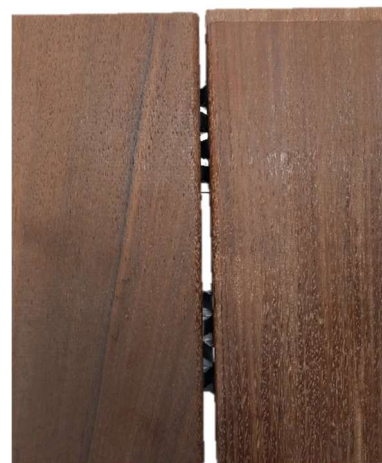

MOD. 156



MOD. 120

STOCK



24. MOPA Y RODAPIÉ



EPE FOAM 2 MM CON PELICULA DE PASTICO



EPE FOAM 3 MM CON PELICULA DE ALUMINIO



EVA 2 MM CON PELICULA DE PASTICO



EVA 1.5 MM CON FILM DE ALUMINIO



IXPE 2 MM ACUSTICO ALUMINIO



LVT 1.2 MM



MULTICORK 10 MM



MOPA BLANCA FOAM-POLIESTILENO EXPANDIDO 3mm con film



MOPA SOUND PLUS 2mm CON BARRERA DE VAPOR



MOPA 2mm LAMINADO CON SOLAPA AZUL DENSIDAD MEDIA



MOPA SILENT ELITE FINSA



MOPA LATEX d BCOVER HP 2.0 ANTIESTATICA HD 2mm



MOPA LATEX d BCOVER ALUMINIO
RADIANTE 1008



MOPA LATEX d BCOVER HD 1.5 mm
LVT VINILICO

RODAPIÉ MDF SINTETICO MOD R-2

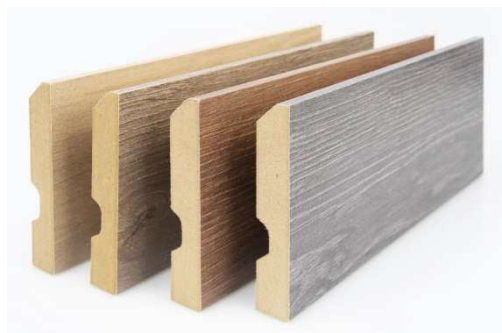

MEDIDA

70*12
90*12
70*16
90*16
100*16
120*16

RODAPIÉ MDF BLANCO MOD R-2



MEDIDA

70*12
90*12
70*16
90*16
100*16
120*16

STOCK

RODAPIE PVC



MEDIDA

70*12

90*12

100*12

RODAPIE CHAPA MDF MOD R-2



70*12

70*16

90*12

90*16



STOCK

RODAPIE PVC BLANCO

ANTIHUMEDAD 100%



RODAPIE PVC

70*12
80*12
90*12
100*12
120*12

PERFIL "L"

100*22

RODAPIE PVC PERFIL "L"



MEDIA LUNA

15*15

RINCONERA

15*15

MEDIA LUNA



STOCK

25. FRISOS SINTÉTICOS

MUNDECOR

MEDIDA LAMA 2700*200*10mm (6 TIRAS POR CAJA)



COMPLEMENTOS

CANTONERA 2700*30*10mm

RINCONERA 2700*30*10mm



Consultar Disponibilidad.



BARIWALL

Es un revestimiento de paredes y techos en base a PVC.

Es un producto de gran calidad decorativa y apto para ambientes húmedos.

Se puede instalar rastrelado a la pared o directamente pegado.

Es ideal para reformas de baños, cocinas, garajes, pasillos. Se puede instalar a panel completo o a media altura.

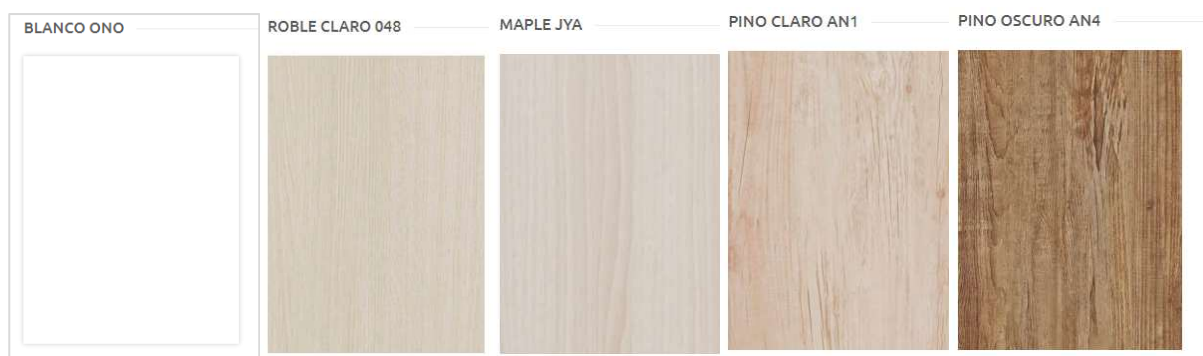

CARACTERÍSTICAS



RESISTENTE A LA LUZ



RECICLABLE



100% RESISTENTE AL AGUA

ÁNGULO VARIABLE



- Medidas: 2200 X 60 X 6 mm
- Base PVC Espumado

REMATE



- Medidas: 2440 X 25 X 12 mm
- Base PVC Espumado

CORNISA



- Medidas: 2600 X 40 X 7 mm
- Base PVC Espumado

RODAPIÉ



- Medidas: 2200 X 60 X 16 mm
- Base PVC Rígido

CELOSÍAS

STOCK

Celosías Sobrepuestas

MEDIDAS: 218 x 85 cm

CLÁSICA CUADRO 20mm



ESTRELLA CUADRO 20mm



CLÁSICA CUADRO 11.5mm



ESTRELLA CUADRO 11.5mm



Celosías Enrasadas

MEDIDAS: 218 x 85 cm

CLÁSICA CUADRO 20mm



ESTRELLA CUADRO 20mm



CLÁSICA CUADRO 11.5mm



ESTRELLA CUADRO 11.5mm



DISPONIBILIDAD DE OTROS PRODUCTOS BAJO PEDIDO

<http://www.fama.nu/>

26. ESCALERAS/FERRETERIA

ESCALERAS ESCAMOTEABLES DE TRAMOS

Madera 3 Tramos



Madera 2 Tramos



Metálica lacada
3 Tramos



Metálica galvanizada
4 Tramos



ESCALERAS DE CARACOL

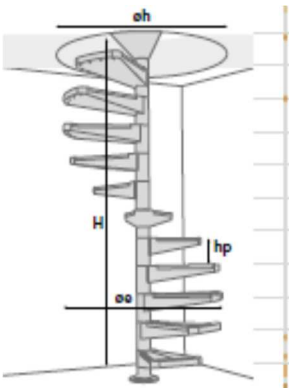

ESCALERAS RECTAS



Para más información pueden visitar la página web: www.maydisa.com/

PASAMANOS

Consultar Disponibilidad.

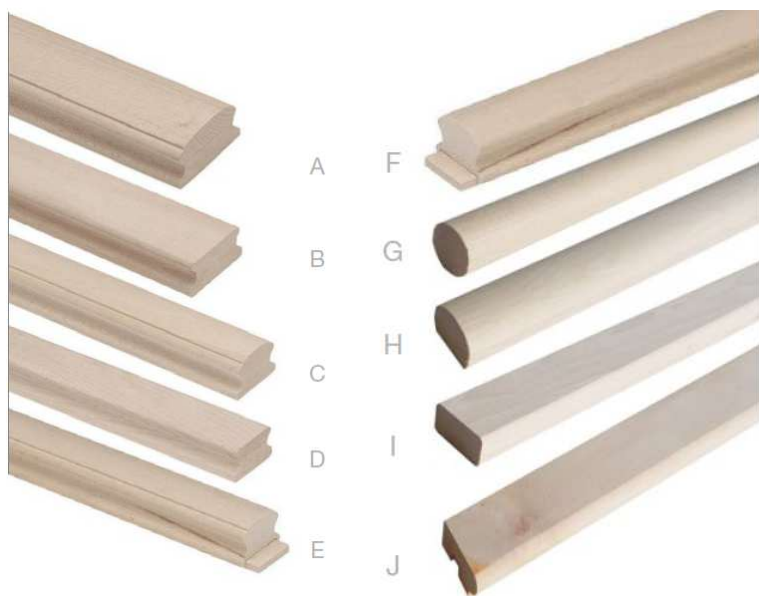

-  Haya / Beech
-  Pino Tea / Carolina Pine
-  Sapelly / Sapelli
-  Roble / Oak
-  Iroko / Iroko
-  Pino Suecia / Sweden Pin

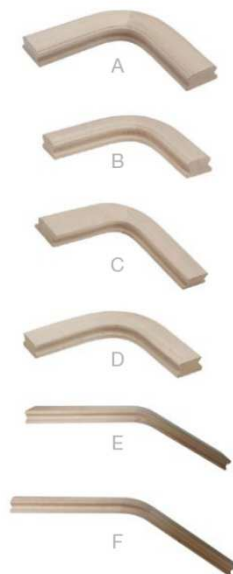

COMPLEMENTOS

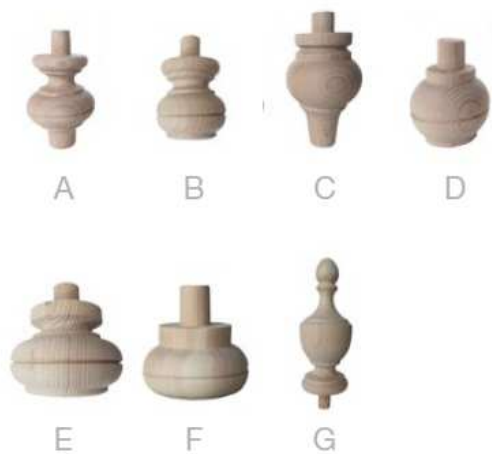

ACCESORIOS

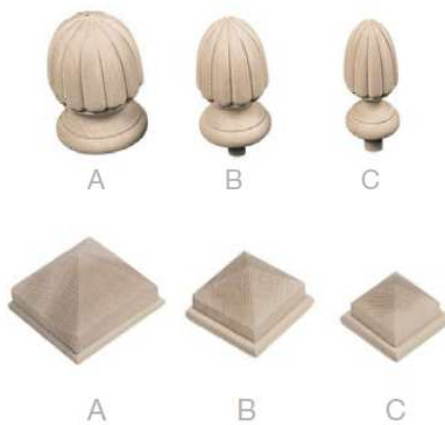

STOCK

FERRETERÍA

TORNILLOS

ANCLAJE ANILLA SN CINCADO/ BC

TORNILLO HECO SCHRAUBEN



Para más información consulta con nuestros almacenes

STOCK

SOPORTES Y ANCLAJES

1-4



5



6



7-8



9-16

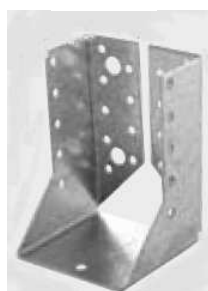

17



18



MEDIDAS

1. SOPORTE ANCLAJE PILAR 91*91*150
2. SOPORTE ANCLAJE PILAR 101*101
3. SOPORTE ANCLAJE PILAR 141*141
4. SOPORTE ANCLAJE PILAR 201*201
5. SOPORTE ANCLAJE PILAR REFORZADO DOBLE 161*...
6. SOPORTE ANCLAJE PILAR REDONDO DIAMETRO 101
7. SOPORTE ANCLAJE PILAR REGULABLE 140*50
8. SOPORTE ANCLAJE PILAR REGULABLE 190*100
9. ESTRIBO METALICO 60*100
10. ESTRIBO METALICO 80*120
11. ESTRIBO METALICO 80*160
12. ESTRIBO METALICO 100*140
13. ESTRIBO METALICO 120*160
14. ESTRIBO METALICO 140*180
15. ESTRIBO METALICO 160*200
16. ESTRIBO METALICO 70*200
17. ESTRIBO METALICO 120*160 (Ala Ext.)
18. UNIÓN SIMPLE 80*40

CABALLETES

MEDIDAS

CABALLETES PINO 80*80



27. JARDINERÍA



CESPED
ARTIFICIAL

<i>Modelo</i>	<i>Altura</i>	<i>Unidad</i>	<i>Muestra</i>	<i>Descripción</i>
Vega	20mm	M2		Césped práctico y económico, pensado para cubrir zonas de paso ligero, terrazas, balcones o pequeños espacios exteriores. Fácil instalación y bajo mantenimiento.
Pontarrón	42 mm	M2		Un césped de gran realismo y suavidad, ideal para jardines familiares. Su altura y densidad proporcionan una sensación mullida y cómoda al pisar, perfecta para niños y mascotas.
Encinar	50 mm	M2		Césped de alta gama con fibras largas y densas, que aporta un acabado premium. Su aspecto natural y confortable lo convierten en la mejor opción para quienes buscan exclusividad y máxima calidad.

- Todos los rollos completos son de 20 m2

Accesorios Césped Artificial



<i>Accesorio</i>	<i>Unidad</i>	<i>Muestra</i>	<i>Descripción</i>
Adhesivo	Envase 1,1 kg Envase 5,1 kg		Cola bicomponente de poliuretano, resistente y de fácil aplicación. Garantiza una fijación duradera incluso en exteriores y condiciones climáticas adversas. Disponible en envases de 1,1 kg y 5,1 kg.
Malla antihierba 125 g	Rollo 2x100 m Rollo 200 m		Geotextil de alta resistencia que evita el crecimiento de malas hierbas bajo el césped. Permeable y fácil de instalar, asegura la estabilidad y durabilidad de la instalación.
Cinta de unión	0,30 x 100 m		Cinta autoadhesiva de alta resistencia, diseñada para unir los paños de césped artificial de manera rápida y eficaz, garantizando un acabado limpio y profesional.
Grapas de sujeción	Bolsa 50 uds		Grapas metálicas en forma de U, diseñadas para fijar firmemente el césped al terreno. Resistentes a la intemperie, aseguran una instalación estable y segura.

- Las imágenes son orientativas y pueden no coincidir con la realidad.





Sigue nuestras Redes Sociales

Maderas Casas Alcorisa

MaderasCasasAlcorisa 
@maderas_casas_alcorisa 

Maderas Casas Teruel

maderasteruel22 
@maderas_teruel 

Maderas Racaso

MaderasRacaso 
@maderas_racaso 